



DESIGN FOR SUCCESS

A DESIGN
& TECHNOLOGY
MANUAL
FOR SMC BMC

Summary

Introduction3

Chapter 1

Performance.....5

Chapter 2

SMC/BMC Manufacturing and Properties.....9

Chapter 3

Design17

Chapter 4

Part Production.....29

Chapter 5

Quality.....35

Chapter 6

Environment39

Chapter 7

Applications49

Chapter 8

Glossary67

Chapter 9

Appendix71

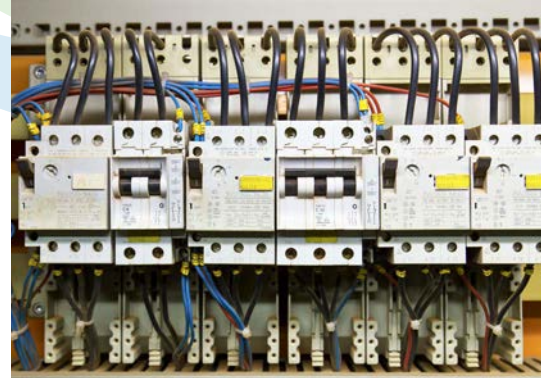



INTRODUCTION

« SMC/BMC
ideal solution
for many
industries



Benefits of SMC/BMC

Your customers demand structural materials that are lightweight, strong and versatile. Materials that resist corrosion and temperature extremes and which deliver freedom of design and low system costs.

The ideal solution for many applications is a family of structural, fibre reinforced thermosets: SMC (Sheet Moulding Compound) and BMC (Bulk Moulding Compound). These materials combine mechanical and physical properties with the lowest system cost, without compromising quality.

This Design Manual provides you with insight in the most important commercial applications of SMC and BMC materials, and the benefits these materials can bring. You will also find detailed information to support you in finalizing your designs.

If you would like to have more detailed information on any of the subjects covered please contact the European Alliance for SMC/BMC. The generic term SMC/BMC has been mostly used although we refer to the specific product types where appropriate.

■ www.smcbmc-europe.org

The European Alliance for SMC/BMC

The European Alliance for SMC/BMC was founded already in 1993 as an industry association of European companies involved in the SMC/BMC technology to promote the technical and commercial advancement of this materials through common activities.

We do this through :

- Providing details on typical end-uses for these material systems
- Explaining the features and associated benefits
- Making available design information to engineers and designs
- Connecting key stakeholders in the supply chain
- Facilitating the information exchange about these materials at selected seminars, exhibitions and organizing Design Award program for young designers in Europe.

Comparisons are made with other structural materials and the excellent environmental and recycling properties of SMC/BMC are communicated to assist designers and manufacturers in the various application fields. Members of the European Alliance for SMC/BMC include manufacturers of resins, glass fibres and additives as well as SMC/BMC suppliers, research institutes and component / system suppliers.



CHAPTER 1

PERFORMANCE

« SMC/BMC:
limited
only by your
imagination

SMC/BMC

Composite solutions

Since the introduction of the first moulding compounds based on Unsaturated polyesters, this class of materials has developed into a variety of high performance SMC & BMC composite solutions for a broad range of applications. In view of their excellent features and benefits, these materials will continue to be used for many demanding applications.



Strength and stiffness

The combination of fibers, fillers and resin results in material systems with great stiffness and mechanical strength. The resin provides the ductility, durability and system cohesion. The fibers are largely contributing to strength and stiffness. Glass fibers, carbon fibers and combinations of the two are being used.



Weight reduction

For reducing Eco-footprint and fuel emission, SMC & BMC Composite solutions can enable manufacturing components with less weight. The mechanical properties of SMC & BMC Composite solutions help to easily replace a large number of metal parts by few composite parts.



Precision and predictability of dimensions

SMC & BMC are first choice solutions for substitution of high performance metal parts where high precision is obtained by means of post-machining processes. Tight tolerances can be produced directly without post operations, ensuring not only cost savings but also increased profitability.

As a main advantage compared to equivalent non-thermoset polymers, the ability to compensate shrinkage with special additives makes even most challenging part designs feasible. For parts with highest precision, materials with negative shrinkage (expansion) can even be used.



Resisting elevated temperatures

Many thermoset polymers are known for their excellent thermal resistance. Using specific resin systems thermal resistances up to 300°C can be achieved. From a technical view these materials can be superior to engineering thermoplastics and provide cost effective solutions especially in comparison to high performance thermoplastics.

For demanding engineering applications it is also crucial that the CTE (Coefficient of Thermal Expansion) is close to the CTE of metals and ensures dimensional stability over a wide range of temperatures.



Part safety through great Fire retardance

Elevated resistance to fire and low smoke generation is important for many applications and markets. For obtaining this high flame retardency a number of additives can be used.

SMC & BMC do not contain any halogens or other hazardous flame retardants. Still they can be formulated having excellent FR properties, even at very low wall thicknesses.



Electrical performance

Excellent electrical performance is a main benefit of using thermoset materials in general.

SMC & BMC Composite solutions bring these excellent electrical properties, particularly electrical strength, water absorption and surface resistivity.

Despite of their excellent electrical insulation properties also materials with reduced surface resistivity and elevated conductivity are available.



Great Class A surfaces

The ability to obtain excellent surfaces for online- and offline painting, as well as for parts metallization is a great asset of working with both SMC & BMC Composite solutions. superior surface aesthetics can be obtained through the unique technology to compensate the material shrinkage.



Low emissions

Interior parts in many end use markets require low emission materials (e.g. car interior parts). Minimization of hazardous or uncomfortable emissions and smell is desired.

Also in lighting systems the headlamp reflectors must be free of any emissions in order to avoid fogging, that will reduce lighting performance.

Applications

This manual sets out to describe Sheet Moulding Compound (SMC) and Bulk Moulding Compound (BMC), their composition, characteristics, processing, end-uses and recycling. Recommendations are given on how to achieve the best results and how to maximise the benefits that these unique materials offer. It is primarily intended to inform and assist design engineers and technicians, especially those working in the following industries:

Electrical & Electronics (mechanical integrity and electrical insulation)

- Low voltage and medium voltage energy systems
- Fuses and switchgear
- Cabinets and junction boxes
- Motor and anchor insulations
- Encapsulation of wiring and electronic circuits
- Electrical components with reduced surface resistivity
- Lamp housings



Mass Transportation (light weight and fire resistance)

- Train, tram interior and body parts
- Electrical components
- Track switch components
- Under the hood components for trucks



Automotive & Truck (low fuel emissions through weight reduction)

- Light weight body panels for vehicles
- Lighting systems, headlamp reflectors and LED lighting
- Structural parts, front ends, interior dashboard parts
- body panels for trucks and agricultural vehicles



Building & Construction (durability and design freedom)

- Drinking water tanks
- Panels
- Doors
- Building supply systems
- Drain and trench covers
- Access chambers



Domestic Appliances (manufacturing in large volumes)

- Iron heat shields
- Coffee machine components
- Microwave ware
- White goods components, grips and handles
- Pump housings as metal substitution
- Motor housings as metal substitution



Engineering (strength and durability)

- Functional parts in mechanical engineering as metal substitution
- Pump components for various media
- Sport equipment, golf caddy
- Safety products for leisure and public application



Sanitary (design freedom and personalised aesthetics)

- Sinks and bath tubs
- Toilet seats
- Drain covers



Medical (optimized shape and user friendliness)

- Surgery equipment
- Dental medication systems
- Antibacterial components





CHAPTER 2

SMC/BMC MANUFACTURING AND PROPERTIES

« SMC/BMC:
industrialised
manufacturing
process

SMC/BMC Manufacturing and Properties

Composition

SMC and BMC, as well as derivatives which include: TMC (Thick Moulding Compound), HPC (High Performance Compound) CIC (Continuous Impregnation Compounds) and AMC (Advanced Moulding Compounds) are all fibre reinforced composite materials which primarily consist of a thermosetting resin matrix (normally UP -unsaturated polyester), reinforcement (normally glassfibre) and inorganic filler.

Additional ingredients such as low-profile additives, cure initiators, thickeners, process additives and mould release agents are used to enhance the processability of the material and the end-performance of the part. Typically less than 30 percent of an SMC/ BMC recipe is a crude oil derivative either as unsaturated polyester resin or thermoplastic additives. The remainder is inorganic filler and reinforcing glass fibres, chopped into lengths: 25 - 50mm for SMC and 6 -12mm for BMC.

Thermosetting resins form the matrix and chemical backbone of SMC/BMC, imparting the required blend of properties. Unsaturated polyester (UP) or vinyl ester (VE) are the resins most commonly used, and they undergo a cross-linking reaction when cured under heat and pressure. VE resins are used when there is a high technical requirement, for example where sustained heat and chemical resistance is needed. Good heat resistance is a characteristic of all thermosets and they differ from thermoplastics in that once the compound cures to a rigid solid, it will not soften at elevated temperatures or become brittle at lower temperatures. This means that SMC and BMC parts retain their original properties and dimensional accuracy over a broad range of temperatures.

Customization and Speed to Market

The ability to tailor SMC/BMC to precisely meet processing and end-use needs is a major benefit over metals. Speed to Market, an essential requirement for automotive OEMs as well as producers of consumer electrical goods, is supported when designing in SMC/BMC. A wide variety of standard material grades is available; alternatively - by varying the type and percentage of ingredients in their formulations - the compounder can custom formulate SMC/BMC materials to meet specific needs.

For example low or high pressure moulding, and end-product performance requirements like high mechanical strength, Class A surface, or flame retardancy. Glass fibre can be replaced by carbon fibre (CF-SMC) for exceptionally low weight, highly rigid parts. Where performance is less critical other materials can be used as a reinforcement. See Future and Emerging Applications chapter.

TYPICAL SMC FORMULATION

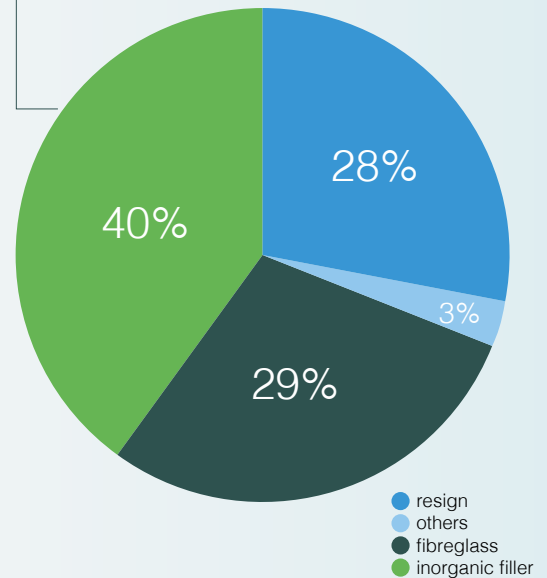

TYPICAL BMC FORMULATION

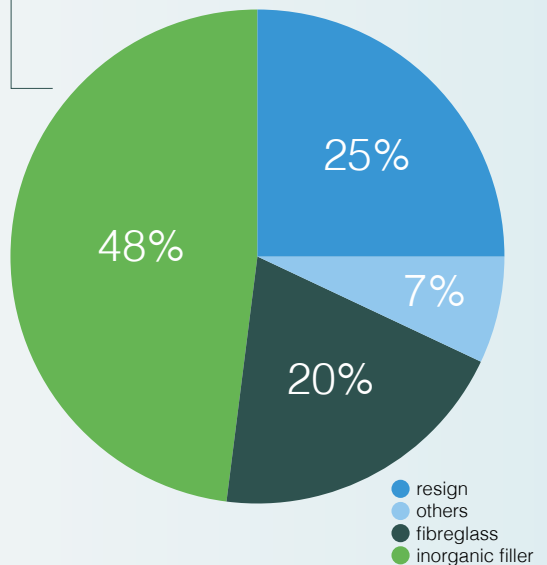

Only 30 percent of SMC/ BMC raw materials are based on crude oil

SMC production

SMC is made as a continuous sheet. The resin paste is transferred to a doctor box where it is deposited onto a moving carrier film passing directly beneath. The doctor box controls the amount of the resin paste applied. Simultaneously, glass fibre rovings are fed into a rotary cutter above the resin-covered carrier film. Fibres are chopped to length (generally 25mm, or 50mm) and randomly deposited onto the resin paste.

'Modern SMC production is a highly automated process'

The amount of glass is controlled by the cutter and by the speed of the carrier film. Downstream from the chopping operation, a second carrier film is coated with resin paste and is laid, resin side down, on top of the chopped fibres. This stage of the process creates a resin paste and glass fibre 'sandwich' which is then sent through a series of compaction rollers where the glass fibres are consolidated with the resin

paste and air is squeezed out of the sheet. Sheet dimensions are normally 4mm thick and 1,500mm wide. The length and weight of the SMC sheet is determined by moulder preference for handling and is usually stored on a 350kg (standard) up to 1500kg rolls or bi-folded (like computer paper) into large bins. Modern SMC production is a highly automated and computer regulated process.

Before the SMC can be used for moulding it must mature. This maturation time is necessary to allow the relatively low-viscosity resin to chemically thicken. The SMC will be kept in a maturation room at a controlled temperature (normally 48 hours at 30°C) and typically requires two to five days to reach the desired moulding viscosity. Usually SMC has a shelf life ranging from several weeks to several months from the date of manufacture. The time frame can be extended or reduced depending on the SMC formulation and storage conditions. A storage temperature of no higher than 20°C is recommended.



■ Rolls of SMC in maturation



■ SMC manufacturing line

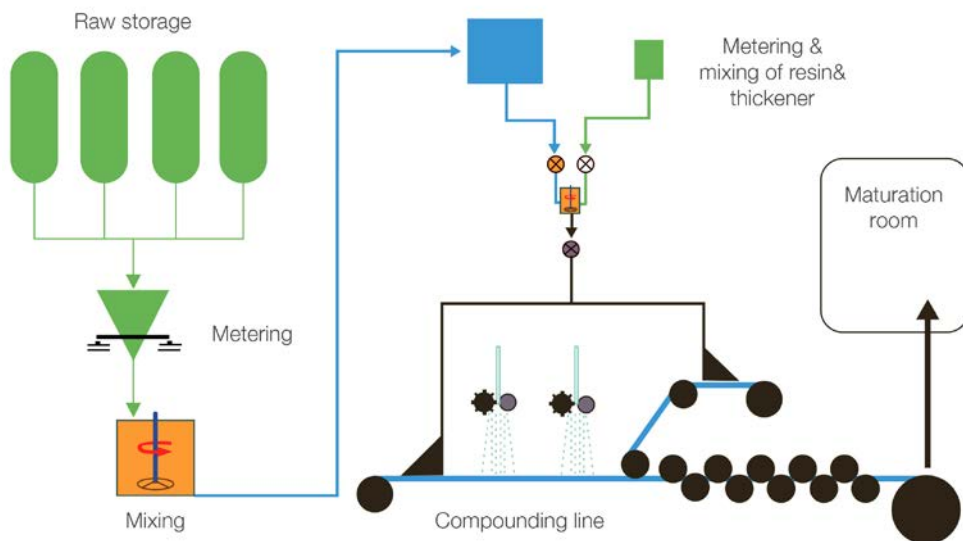



■ Decklid for this convertible model is moulded in SMC

Low-Profile SMC material characteristics

SMC can be formulated with a broad range of resin and reinforcement combinations to impart and enhance specific properties. For Class A surface requirements, for example, thermoplastic low profile additives are used to control the amount of shrinkage of the resin system during polymerisation. A general purpose formulation will have a shrinkage of around 0.2%, whereas a low-profile SMC will typically be as low as 0.05%, some are even zero shrinkage. Once cured SMC/BMC products show no post mould shrinkage what so ever. This is a particular benefit in the automotive industry, where low profile Class A SMC panels are often used alongside steel or aluminium in a hybrid design. Dimensional stability ensures precise panel fit and interface.

When BMC is used

Due to its longer fibre length and higher fibre content, SMC has greater flexural strength and tensile strength than BMC. As a result the material tends to be used for larger flat parts with a more structural requirement combined with good cosmetics - such as vehicle body panels or building cladding panels. See Applications chapter for more details. Strength, rigidity and corrosion resistance are also essential attributes in other common SMC applications such as passenger car decklids, truck grilles, water storage tank panels and electricity meter cabinets.



Low –Profile SMC: formulations with very low or zero shrinkage

BMC manufacturing process

Like SMC, BMC is a fibre reinforced composite material which primarily consists of thermosetting resin, chopped glass fibre reinforcement and filler in the form of a bulk material. Additional ingredients such as low profile additives, cure initiators, thickeners and mould release agent are added to enhance processing performance. BMC is less loaded with glass fibres than SMC and fibre length is shorter at 6 to 12mm. Filler loadings are higher than for SMC. There are several techniques for the batch production of BMC. The most common mixing process involves a Z-blade mixers which amalgamates the resin paste, fillers, additives and reinforcements into a mass material with a dough-like consistency. The bulk product is packed in plastic bags impermeable to styrene diffusion and supplied in bins. Like with SMC, it can be supplied in pre-weighed charges according to customer needs.

When BMC is used

Due to the shorter fibre length, BMC is well suited to injection moulding where it flows freely into the smallest cavities, making it suitable for the most intricate parts. The higher inorganic filler load guarantees very high temperature resistance and an extremely good surface appearance, which is why BMC is commonly used for headlamp reflectors and appliances requiring good cosmetic and high heat performance such as steam iron housings and coffee machines.



BMC is ideal for heat resistant parts

Top right and above: A steam iron and a coffee machine: Two typical examples of BMC being used for its surface aesthetics, water resistance, electrical insulating properties and high heat stability.

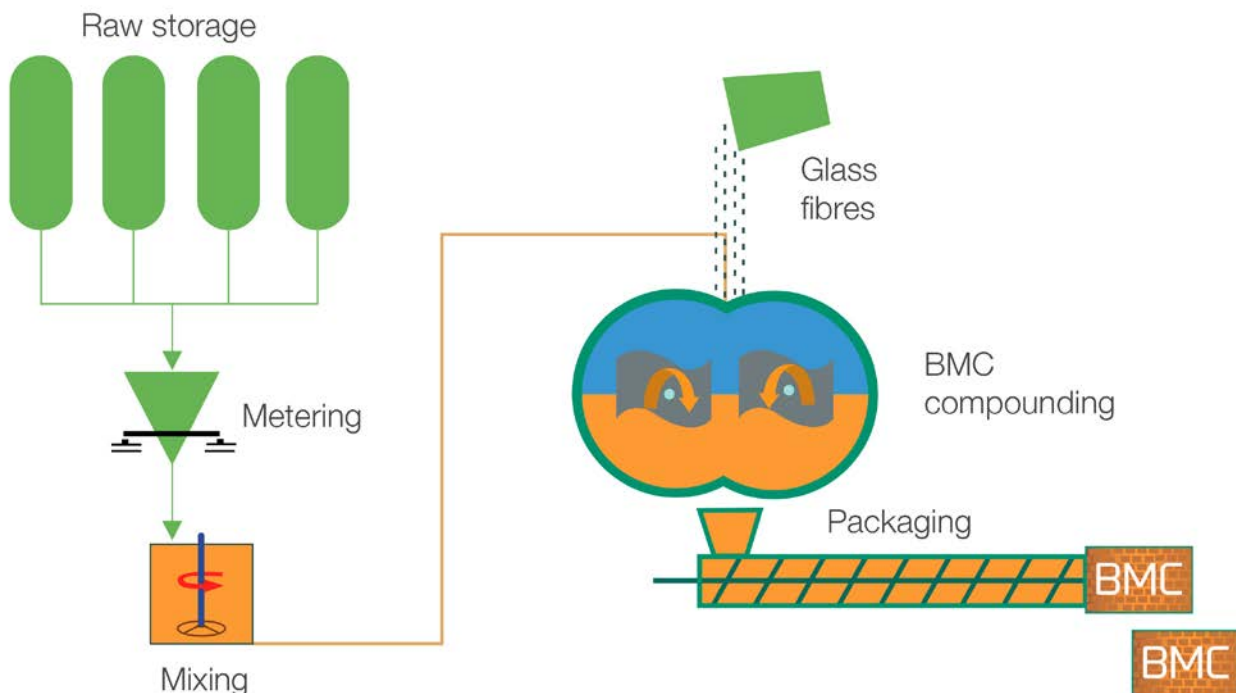

BMC combines excellent electrical and mechanical properties with good mouldability and high dimensional accuracy in the finished part. An advantage over traditional thermosets commonly used for electrical and heat sensitive parts is that BMC can be pigmented to a wide range of colours. See Applications section for more details.

For more information about BMC please see our website www.smc-alliance.com or request a copy of our brochure 'Bulk Moulding Compound.'

Benchmarking versus competitive materials

To get a true picture of the performance of SMC/BMC we need to compare the material's properties versus competitive materials like steel, aluminium and thermoplastics. The benchmarking tables that follow show how well SMC/BMC compares to metals and other plastics.

Unlike other plastic materials, SMC/BMC dimensional accuracy is retained across a wide temperature range

Retention of dimensional properties: SMC compared with other polymers

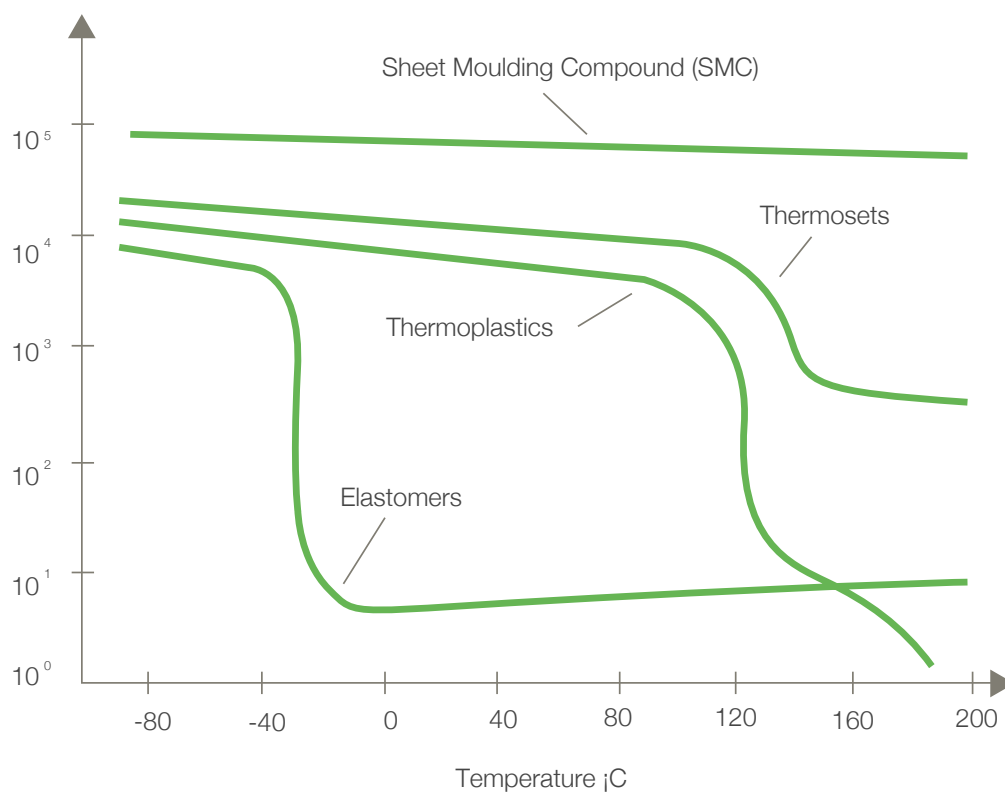

Benchmarking

MATERIAL	STEEL	AL MG	THERMOPLASTICS	SMC/BMC
Part consolidation	---	O	+++	+++
Customizing	---	---	+	+++
Corrosion resistance	---	---	++	+++
Low weight design	---	+++	++	+++
Fire resistance	+++	(++)	---	+++
Specific stiffness	--	+	--	+++
Water absorption	+++	+++	---	+
Online paintability	+++	+++	--	+++
Temperature resistance	+++	++	---	++
Mass colouration	---	---	+++	+++
Recyclability	++	++	+	+
E-Permeability	---	---	+++	+++
Eco efficiency	--	---	O	++

+++ : positive --- : negative O : neutral

Sound dampening of various materials

MATERIAL	LOSS FACTOR
Aluminium	7×10^{-5}
Steel	2×10^{-5}
SMC	0.40
Polyamide	0.16

The sound transmission loss from SMC/BMC parts is much better when compared with aluminium. The loss factor for SMC is significantly higher than aluminium, meaning that SMC/BMC engine parts like valve covers and oil sumps contribute to reduced engine noise, harshness and vibration.



SMC/BMC valve covers and oil sumps feature significant sound dampening properties

Tensile strength MPa

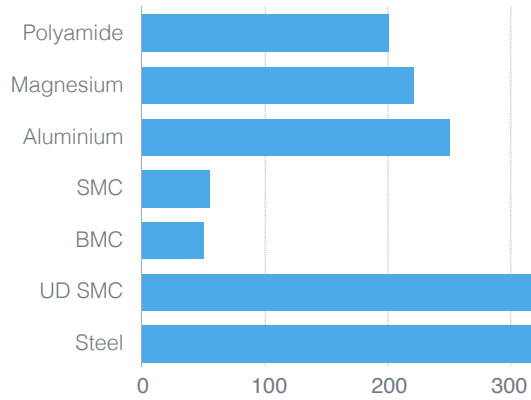

Young's modulus GPa

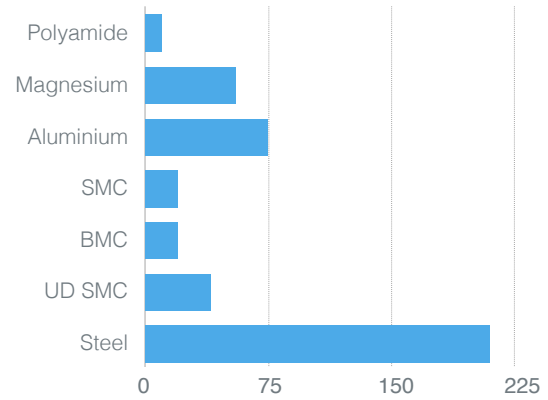

Density g/cm³

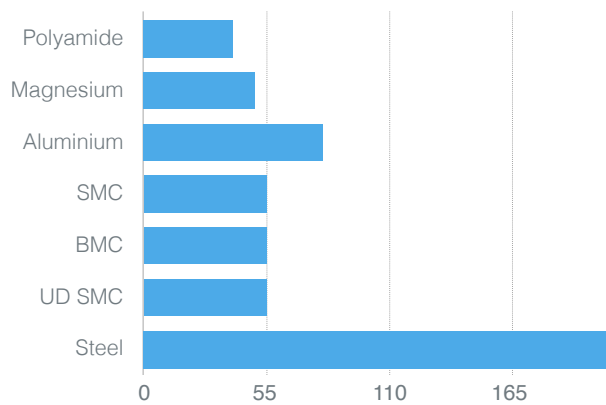

Light weight potential

Equivalent flexural stiffness: steel is 100%

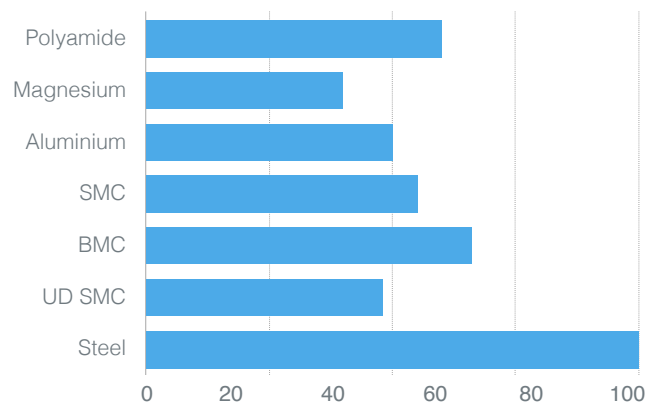

Coefficient of thermal expansion (CTE) 10⁻⁶ m/mK

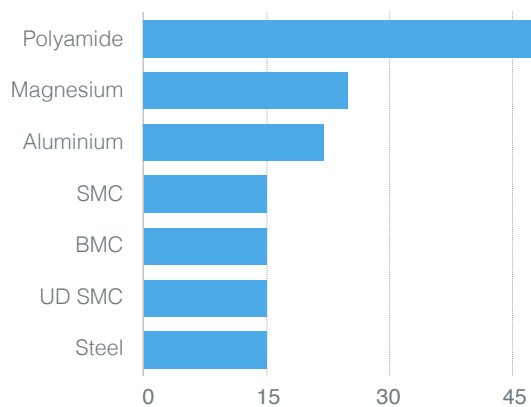



CHAPTER 3

DESIGN

« SMC/BMC:
optimised
part design

Designing and modeling with SMC/BMC

SMC/BMC materials offer exceptional flexibility to the designer: for example a design based on mouldable SMC/BMC can produce a highly complex, multi-functional part that could not be realised in metals.

First stage in the design process is to create a computer aided design (CAD), using numerical modelling such as finite element analysis (FEM). To create an accurate and representative design model, good knowledge of the materials' behaviour and capabilities are needed. SMC/BMC properties are well known, which makes it a favourable choice for designers. With the mechanical properties, (given in the appendix), a designer can create a CAD model and simulate mechanical reliability using FEA and can rework the design as necessary. We've used the example of a virtual car bumper beam to illustrate this process.

The CAD model is transferred into a meshed structure, which consists of 3-dimensional geometrical elements and forms the basis for flow simulation. Each element owns specific physical properties, which are linked. The diagram shows the result of the flow simulation of the bumper beam. In the blue area the SMC is placed in the mould and, with the application of moulding pressure, starts to flow. The red colour indicates the flow front, which reaches (step 3), the edges of the cavity. The main results obtained via the flow simulation, are firstly the filling time and secondly whether the cavity is completely filled and if there are weld lines, where the material meets. Weld lines should be avoided, especially on visible parts.

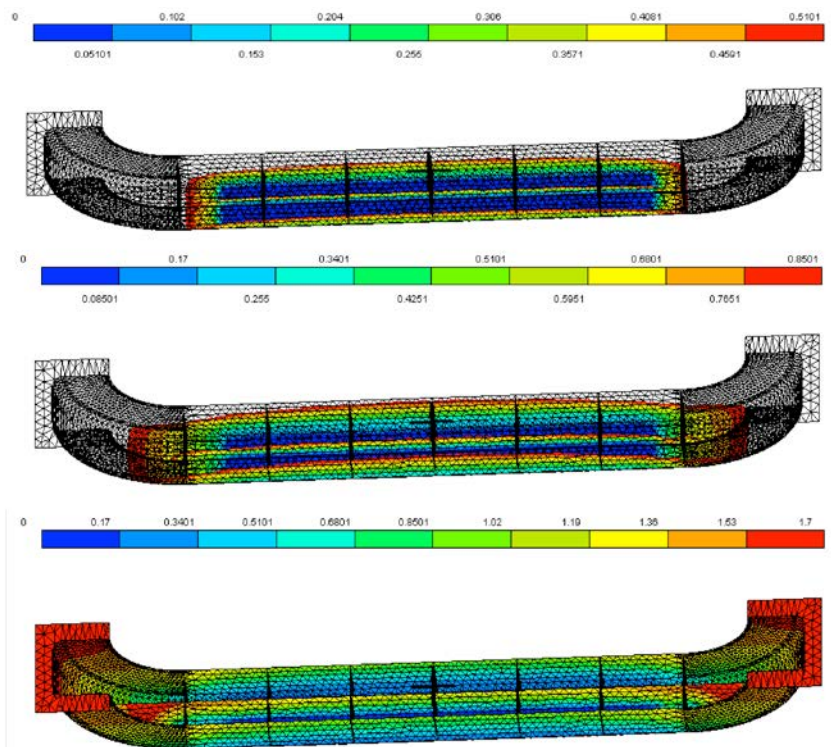

■ Simulation of the filling-process, showing the time evolution of the flow front during the filling process

Flow simulation predicts cavity filling behaviour

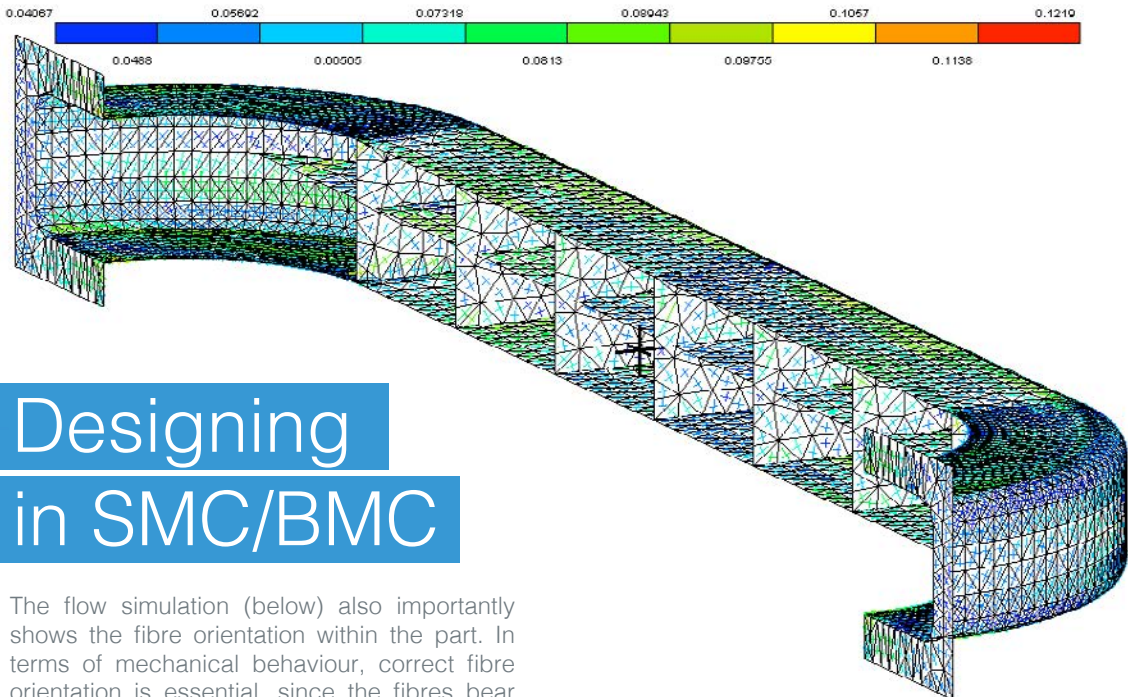

Designing in SMC/BMC

The flow simulation (below) also importantly shows the fibre orientation within the part. In terms of mechanical behaviour, correct fibre orientation is essential, since the fibres bear the loadings and stresses. In a successful SMC part, the design has to enable the fibres to flow along the load direction - so the design must include the right flow characteristics.

Structural analysis

Structural analysis can then be performed. By adjusting reference conditions the impact of dynamic and static forces and excitations can be calculated. The simulation below shows the mechanical behaviour of the bumper beam under a single static load. The deformation is clearly shown and the colours indicate the resulting tension within the material. Now the designer can decide whether the stresses are acceptable or if the design needs modification.

Correct fibre orientation is essential to cope with mechanical loadings and stresses

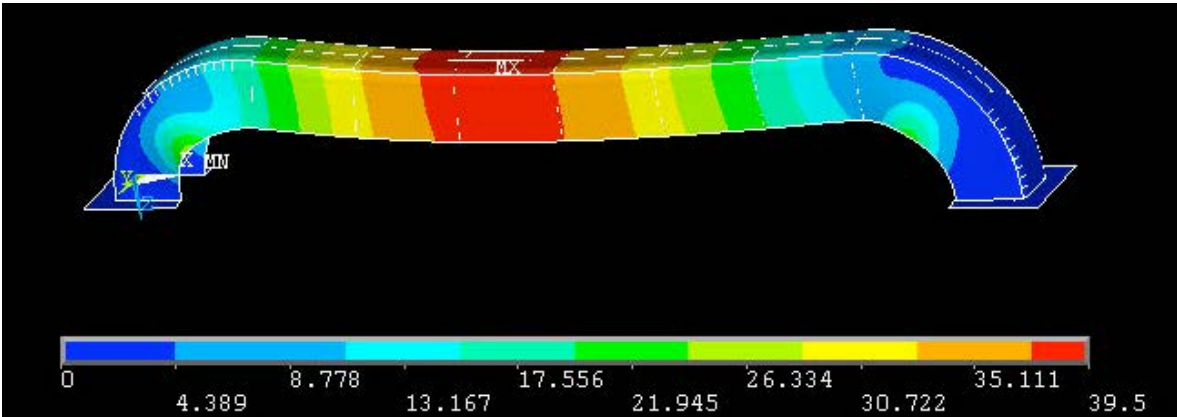

Clean-Sheet Design: new products in SMC/BMC

Review the design objectives

Determine from the outset what the primary objectives are for the SMC/BMC components.

Select a development and production partner

It is very beneficial to select a partner familiar with the whole knowledge chain as early in the design process as possible. Validate the design for structural performance, appearance and cost issues. To maximise the advantage of SMC/BMC in terms of cost/performance ratio, and to avoid design loops.

Review the product specifications

Having established the primary objectives, determine what role SMC/BMC plays in meeting these objectives.

For example, if high quality body colour surface finish is important then emphasis must be placed on achieving Class A surface appearance. For example trim edges must be hidden or closely controlled.

If low weight is a major concern, then lower material usage, will be one of the main criteria. This means minimizing redundant structures, consolidating parts or using specialized low density grades of SMC/BMC.

Review the design

When the design is complete, review the CAD model:

- Inspect the surfaces for die draw and possible undercut conditions
- Determine die draw direction
- Check the surface for narrow sections to surrounded parts
- Design shear edges and trim areas

Designing beneath the surface

SMC closed sections can be designed to carry the same loads as steel but sufficient package space is necessary for bending stiffness, seal loads, torsion stiffness and deflections, for example.

Preliminary structural evaluation

Preliminary structural and fastener loadings can be evaluated using finite element analysis (FEA) as previously described. CAD checks can also be made for recommended design clearances and tolerances.

Replacement of a current design that's not in SMC/BMC

When replacing an existing design or part, most issues have already been determined:

- Attaching interface
- Body package
- Margins, fit and flush
- Performance of the previous part.



Design benefits of SMC/BMC

- SMC/BMC closed sections can be designed to take the same loads as steel
- The coefficient of linear thermal expansion for SMC/BMC is close to steel and aluminium
- The 'spring-back' associated with steel or aluminium does not exist with SMC/BMC
- Low Profile Class A System shrinkage is zero or no more than 1/2 mm/m
- Tools are built directly from the designer's mathematical calculations
- Read-through effects of SMC/BMC are very low compared to thermoplastics

Is existing component space sufficient?

For example: outer shell at 2 to 3 mm thick plus adhesive 0.5 to 1.5 mm gives a depth of 4.5 to 7.5 mm

In addition to SMC's increased material thickness, cross sections must also be increased if they are to carry the same loading and provide the same stiffness.

If package size is insufficient then the following steps can be taken:

- Increase package
- Reduce loading
- Make stiffness concessions
- Locally reinforce SMC part

Are current fasteners and locations adequate?

Analyse CAD data using FEA.

Are fit & flush and tolerance bands still applicable?

Compared to other materials, SMC/BMC components require no specific attention as far as temperature influence is concerned. That's because the thermal expansion of SMC/BMC is very similar to metallic components (see paragraph on CLTE for further details).

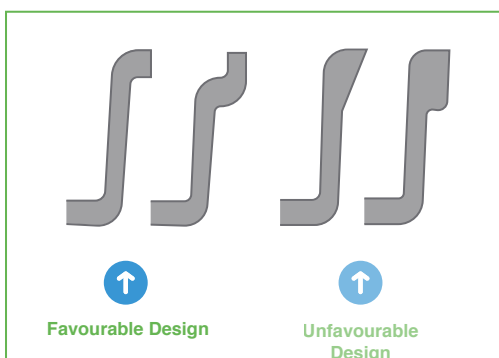
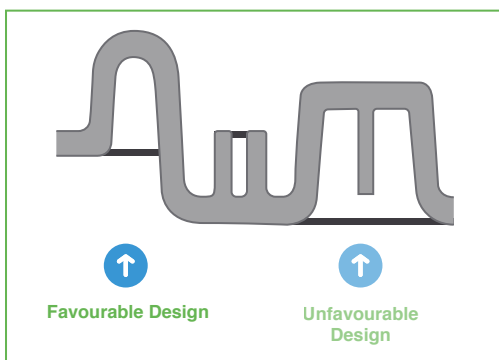

Basic design considerations for SMC/BMC components

- To increase moments of inertia use contoured surfaces
- Wherever possible in the design consider points of inertia e.g. styling lines, corrugations or ribs
- If panels are too thick this will further increase non-linear curing times
- Recommended outer panels: 2.0-3.0mm thickness
- Recommended inner panels: 2.0-3.5mm thickness
- Recommended curing times: 30 seconds to 45 seconds per mm thickness
- Maintain uniform wall thickness for uniform flow, uniform curing and the minimization of warpage and distortion. This also minimizes read-through where there are thickness changes (non-Class A design).

Keep wall thicknesses constant to avoid thin to thick sections along material flow paths and at the end of the flow - so as not to impair excellent surface quality and isotropic properties

Ribs

SMC/BMC parts can be strengthened and made more rigid by incorporating ribs and bosses into the design. But ribs are not used on Class A outer panels because they can create sink marks (opposite) - localized depressions in the surface of moulded parts caused by the non-uniform shrinking of the SMC/BMC during the cooling process. In cosmetically critical parts, they can be a serious problem. Sink marks are dependent on part geometry and material shrinkage rates.

For Non class A component design, sink marks can be minimized or eliminated by the proper design of reinforcing ribs using the right combination of draft angle, radii and rib thickness as indicated in the diagram opposite.

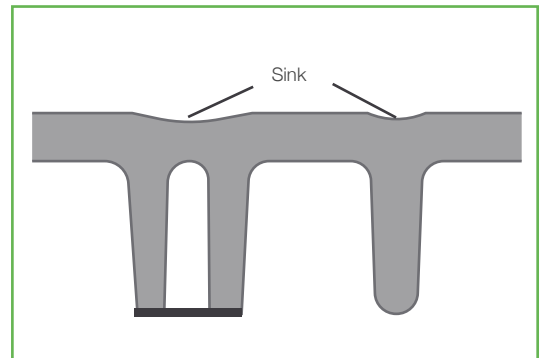

Radii

The recommended radii is 2mm minimum for inside corner radii and 1.5mm minimum for outside corner radii.

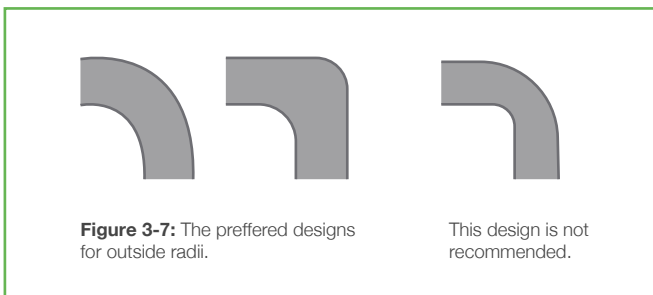
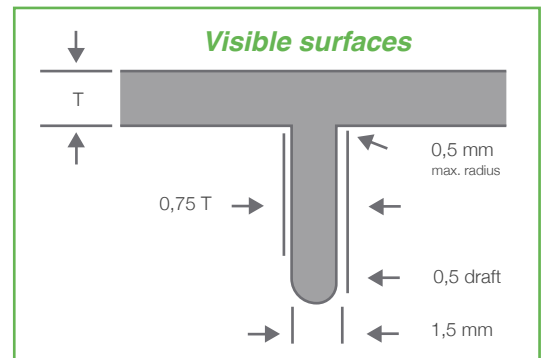

Recommended minimum draft angles

PART	NON-VISIBLE SURFACES	CLASS A SURFACES
RETURN FLANGES	1,5°	1.5° 3.0° with in-mould coating
RIBS	1,0° per side	0.5° per side in localized areas only

Thinner wall sections

Reduce overall component weight by diluting non-loaded areas. The larger the area, the less reduction there should be in wall thickness. Diluted thickness is approximately 75 – 80% of normal.

Openings & holes

Holes are best achieved via a secondary drilling, punching, routing, or water-jet cutting operation. Larger openings require shear edged tools around their periphery.

Bosses

Special design rules for bosses (self-tapping screws) are necessary:

- Detailed design is subject to material and load factors
- Bosses must be designed 25 % longer than the fastener
- Boss diameter should be 2.5 times cored hole diameter
- Torque and pull-out strength should follow suppliers recommendation
- The specific design (asymmetrical thread, recessed thread root & special cutting notch) reduces the risk of bosses cracking and increases tightening, break-loose and pull-out forces.
- An assembly operation repeated more than five times will require threaded inserts
- The bonding-in of bosses is also possible

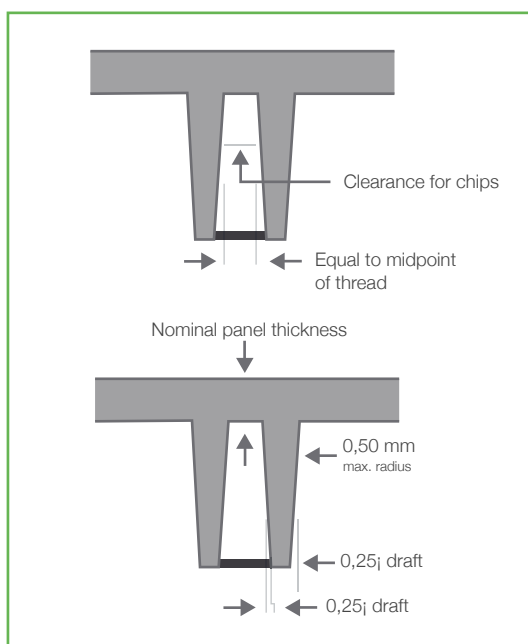

Inserts

Moulded-in inserts are for frequent assembly / disassembly tasks. Alternatively (if the screwing direction is not aligned to the moulding direction) inserts are normally applied in a separate secondary stage. Both require a definite clearance off the mould surface of typically 0.5mm to prevent or minimize torque retention. Moulded-in and standard inserts both require mechanical undercut conditions to achieve the necessary friction otherwise unobtainable with plain geometries. Various designs are shown under DIN 16903 (insert nuts for mouldings). The material of choice for inserts is brass.

We suggest that you contact a specialized supplier of inserts for best practice advice and solutions.

Trimming

Design Engineers should locate trim edges in non-appearance areas of the part. All SMC/BMC parts require trimming of flash (de-flashing). The trimming operation is either performed automatically by robots or by hand.

Variations on trim edges

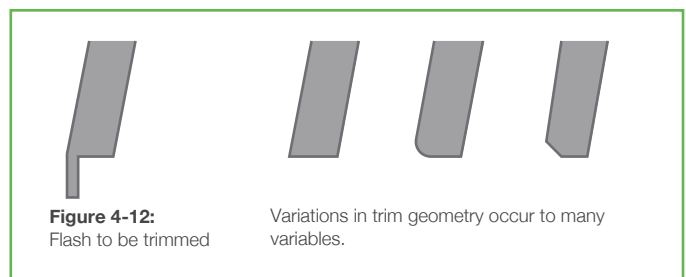

Structural parts and other non-visible parts require a simple de-flashing operation to achieve smooth edges (technical de-flashing).

Visible parts like exterior body panels may require defined radii or minimal radii of ≥ 2.5 mm due to legal requirements. (optical de-flashing). Trimming is much more sophisticated and, whenever possible, clearly visible or uncovered trim edges should be identified early in the design stage to reduce later remedial work.

Drills and punches

Drills are used for round holes while punches may be used for round, rectangular, or irregular shaped holes. Design all holes to be punched or drilled in the same direction to minimize costs. Drilled holes are better in appearance than punched ones. Sufficient edge distance and clearance is also important - Distance to edge $\geq \frac{1}{2}$ hole diameter.

Routers

Routers are used for large, irregular holes or specialized edge trimming. High speed routing on NC-controlled machines ensures high accuracy and quality of the resulting edges and apertures. By using appropriate cutting tools for thermoset materials, clean cuts over a prolonged period are assured. Closely monitor the tools for wear and tear due to the abrasiveness of glassfibres.

Water jet

In water jet cutting the jet of water passes through the SMC part leaving a clean cut. Water jet cutting doesn't generate dust particles but they have to be cleaned afterwards. The cut of the water stream is about 0.5mm wide.

Threaded-in fasteners

Body panels attached directly to body-in-white structures are attached with threaded-in fasteners. Through-holes are required for fasteners to thread into the body structure.

Threaded fasteners for bosses
Design rules are as above.

Tolerances

Plastic parts' tolerances come under ISO 2577 (DIN 16901). Table 130 is applicable for SMC parts. Deviation values are distinguished between tool and non-tool related figures. Compared to thermoplastic values, a higher level of precision can generally be achieved. Deviations are influenced by variations in:

- Glass fibre content and fibre orientation
- Minor internal stress due to small deviations in cool-down related to geometrical issues. These may increase tolerance requirements for production.

Bond flanges

The bond line thickness should be between 0.5 – 3.0mm. Recommendation for a target bondline thickness is 1mm, which offers sufficient space to allow for tolerance. A thickness below 0.5mm is not recommended. In the worst case scenario the bondline thickness should be greater than 0.2 mm. Most adhesives are capable of filling gaps even wider than 3.0 mm, although this will have a negative impact on bond performance and is not recommended. See section 'Designing for bonding.'

Tapping plates and stud plates

Tapping plates consist of flat or formed sheet metal with threads for accepting fasteners. Threads are achieved by

weld-nuts, caged nut assemblies (if adjustability is required), or formed threads in the sheet metal itself. Tapping and stud plates can also be bonded in. They will distribute loads over a larger area and are recommended where loads exceed boss pull-out strengths.

Note:
Panel should be sandwiched between the plate and the fastening surface, wherever possible, to assist in load distribution and fastener torque retention. ghosting of the topcoat due to differences in thermal coefficients, so they should be avoided. Plates opposite Class A top-coated surfaces may cause ghosting of the top-coat surface due to differences in thermal coefficients, so they should be avoided.

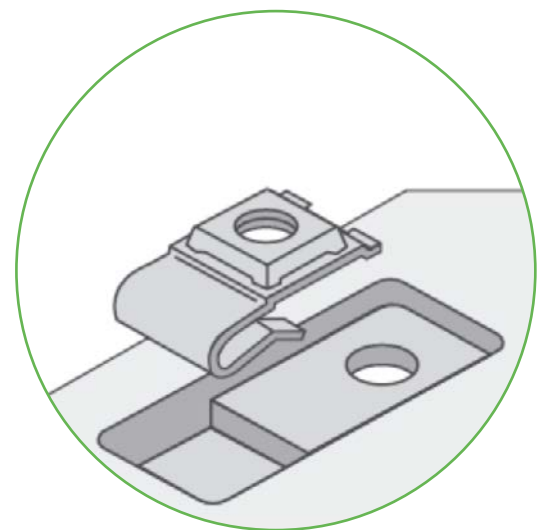

Through-holes for fasteners

General requirements for holes apply.

U-Nuts

Clearance holes for U-nuts can be formed in SMC/BMC parts.

Rivets

Wherever possible, design the assembly so that the head of the rivet assembly lays against the SMC/BMC part. A back-up washer is recommended to minimise the possibility of cracking.

Alternative fasteners

Christmas-tree, press-in or snap-fit action.

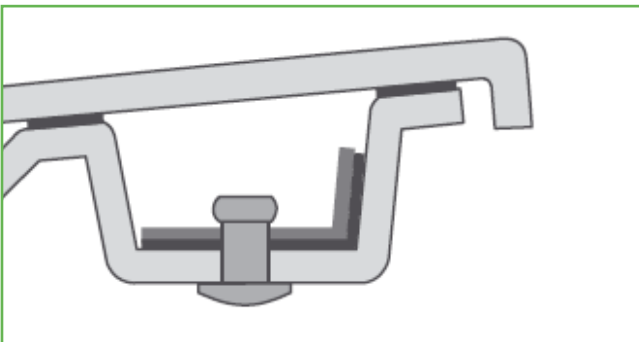

Torque requirements

Torque retention is very low.

An applied torque of 10 Nm (i.e. M6 torque) will have a retention of approx. 25% after 240 hours. Different types of SMC do have specific retention behaviours therefore evaluation trials to determine exact values are recommended during development.

Material related design considerations

Shrinkage

Frequently used SMC types can be divided into LPA (Low profile Class A) and LS(Low shrinkage) systems. LPA systems have a shrinkage of -0.05% to 0% whereas LS systems range between 0% to 0.1% maximum.

Post shrinkage

Post shrinkage over time or after additional temperature load, such as painting or climate influences, is negligible or non-existent.

Coefficient of Linear Thermal Expansion (CLTE)

The slope of the line representing dimensional change as a function of temperature is known as the CLTE.

SMC components require no specific attention in this respect compared to other materials, especially non-ferrous metals like aluminium.

CLTE comparison

Steel	12 x 10 ⁻⁶ /°C
Aluminium	24 x 10 ⁻⁶ /°C
SMC	12-16 x 10 ⁻⁶ /°C

Tool design

The design for SMC/BMC production tools follows similar rules as for any other production process within the plastic industry.

Production tools must be of the highest quality and capable of producing parts consistently and economically throughout the expected production lifetime.

During compression moulding, cavity filling takes place as soon as the mould is closed. The result is shear edges along the circumference of the tool cavity, along all apertures in the tool as well as on undercut - if moving cores or slides are incorporated.

To avoid knit lines, holes and break troughs are not built into tools but are produced in secondary operation processes.

The general arrangement of a tool allows for an internal pressure during the process of 100 bar.

Production tools must be of the highest quality and capable of producing parts consistently and economically throughout the expected production lifetime

General tool arrangement

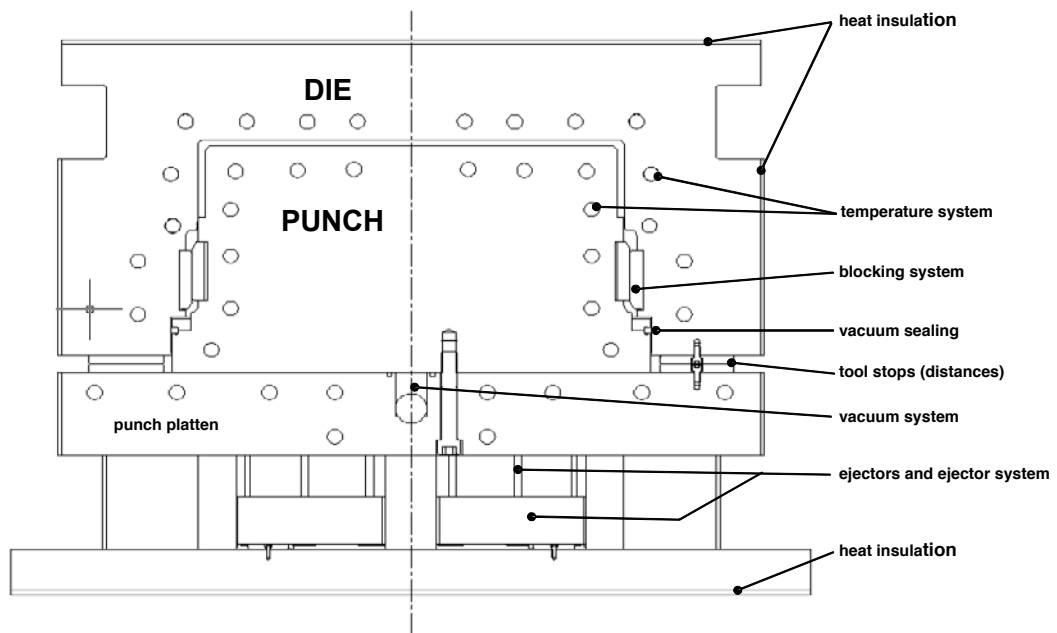

Tool materials

Depending on the application and expected service life production volumes, materials like aluminium and steel (unquenched and untempered) are used. These materials will be used predominantly for prototype tools, but for serial tools quenched and tempered steel sorts like 1.2311 or 1.2738 (German steel key figures) are normally used. Dies for Class A products with high volumes may even require 1.2738 TS steel.

Temperature system

The working temperature of the tools is usually 140 °C to 160 °C. When designing the temperature system it is essential to be able to maintain surface temperature within very close parameters. A symmetrical layout of the temperature system's circuits have been proven. Normal heating systems are steam, oil, high pressure water or electricity.

Wear protection

High volume production requires protection of a tool's surfaces against abrasion. Processes like hard chrome-plating or laser-hardening will be used, and chrome

plated surfaces are recommended; especially for LP-SMC.

SMC/BMC materials have minimal process shrinkage. This behaviour require very close attention in the design stage with regard to deformation - so called draft angles. Generally speaking: the bigger the better!

On the tooling side, air vents and an optimized layout of ejectors are necessary to remove parts from the tool well. But outer shell parts with class A requirements must not have ejectors.

■ Vacuum system

Class A parts are produced with vacuum assist compression moulding. Insulation of the tool's inner cavities against vacuum leakage is also essential.

■ Sensors

Sensors to measure temperature, process pressure, vacuum status etc. should be standard for any SMC/BMC tool.

Part ejection

SMC/BMC materials have minimal

process shrinkage. This behaviour require very close attention in the design stage with regard to deformation - so called draft angles. Generally speaking: the bigger the better!

On the tooling side, air vents and an optimized layout of ejectors are necessary to remove parts from the tool well. But outer shell parts with class A requirements must not have ejectors.

Vacuum system

Class A parts are produced with vacuum assist compression moulding. Insulation of the tool's inner cavities against vacuum leakage is also essential.

Sensors

Sensors to measure temperature, process pressure, vacuum status

High volume production requires protection of a tool's surfaces against abrasion

Designing for Adhesive Bonding

The physical properties of both the adhesive and the parts to be bonded needs to be considered during the design phase of a part. Typically bond flanges should range from 16 to 25mm.

A minimum flange width of 6mm may be used on smaller parts such as spoilers and a minimum of 3mm clearance from the tangent should be allowed between the edge of the inner panel and the return flange on the outer panel. This allows for positive location in the fixture and adhesive de-ropping.

Bonding for Class A

For Class A surfaces, especially high-visibility horizontal applications such as hood assemblies, it is preferable for the bond location to be restricted to the panel perimeter and surface contour changes. This greatly reduces the risk of bond read-through.

Elastic, low modulus adhesives, can be used in such areas because, in most cases, these adhesive don't have a high loading requirement - they are just acting as so called 'anti-flutter-adhesive'. All closures must be vented to prevent air from being trapped in the assembly. Trapped air might expand and distort the surface when exposed to paint oven temperatures. Vents can be provided by interrupting the adhesive line or by providing a vent hole.

It is best to design locating features, which help the part be to self-locating in the bonding fixture, on the inner panel. If these features are located on the outer panel, there may read-through to the Class A surface. This also applies to moulded-in spacers that define the bond line thickness.

Ideally all bond areas should be aligned in the direction of the clamping force. Adhesive application to vertical surfaces should be avoided to prevent the wiping and removal of adhesive as the parts come together. In large complex assemblies it may necessary to use multiple overlapping inner panels to eliminate adhesive wiping.

Surface preparation prior to bonding

For Class A surfaces, especially high-visibility horizontal applications such as hood assemblies, it is preferable for the bond location to be limited to the panel perimeter and surface contour changes. This greatly reduces the risk of bond read-through. Elastic, low modulus adhesives, can be used in such areas because, in most cases, these adhesive don't have a high loading requirement - they are just acting as so called 'anti-flutter-adhesive'.

State-of-the-art adhesives for bonding of SMC/BMC in many cases simply require a dry or solvent wipe to remove contaminations like dust, oil, and excessive mould release. The applied mould temperature therefore not only accelerates the cure of the adhesive to allow short cycle times but also acts as a 'primer' absorbing release agent and ensuring good anchorage of the adhesive to the substrate.

For ambient curing 2-part adhesives and moisture curing 1-part adhesives, a light sanding of the surface or the use of primers may be required. Primers can affect the appearance of Class A surfaces if applied directly to areas that will be coated.

Precautions should therefore be taken to ensure primers do not come into contact with Class A surfaces. Recently 'Open Air Plasma' technology has been evaluated with positive results for use on SMC/BMC. This technology eliminates the need for manual solvent wipe or sanding and replaces them with automatic and controllable process.

See Chapter 4 for more details on adhesives and bonding

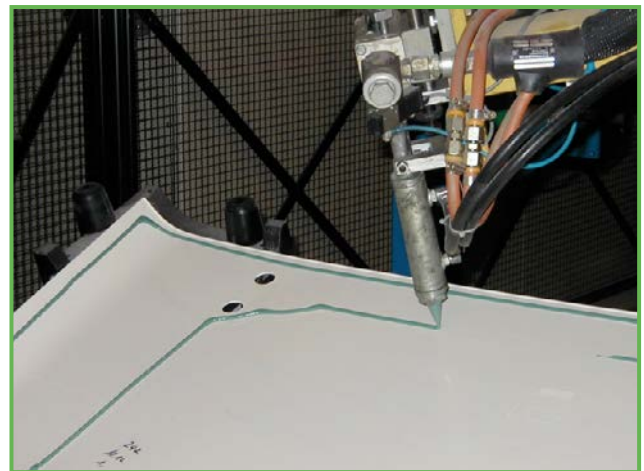

■ Adhesive application by robot



■ Class A SMC tailgate

Designing for Class A painted parts

Class A parts should be designed using certain precautions for optimizing the performance of the substrate and to minimize any possible source of defects. Aesthetic parts have an optimal thickness between 2.0 and 3.0mm, so ribs and bosses should be avoided and trim edges positioned in non-appearance areas. Where a two-piece design is used for Class A parts, bond flanges opposite to surfaces should be avoided.

Bond flanges should be positioned in low visibility areas, at the panel perimeter or behind surface contour changes. Moreover, proper bond fixture adjustment and heating should be controlled in order to avoid distortions that may impair surface aspects.

For a Class A surface finish, a Low Profile SMC/BMC formulation must be specified. Dramatic improvements have been made over the last decade in formulating Low Profile SMC and BMC that combines excellent surface smoothness with toughness, low water and moisture absorption, and high temperature stability for online painting.

Attention should be given to the choice of moulds.

Forged steel must be used to reduce the possibility of porosity in the mould cavity. The finish of the mould should be properly maintained to avoid any long term waviness. All moulds for Low Profile SMC parts must also be chrome plated.

**See Chapter 4
for more details on painting**

For a Class A surface finish, a Low Profile SMC/BMC formulation must be specified

A black and white photograph of an industrial robotic arm in a factory. The arm is white and has 'ROBOS' written on it. It is positioned in the foreground, with various mechanical parts and pipes visible in the background. The scene is dimly lit, with some light coming from the left. A large blue semi-transparent overlay covers the right side of the image, containing text.

CHAPTER 4

PART PRODUCTION

« SMC/BMC:
industrialised
part production

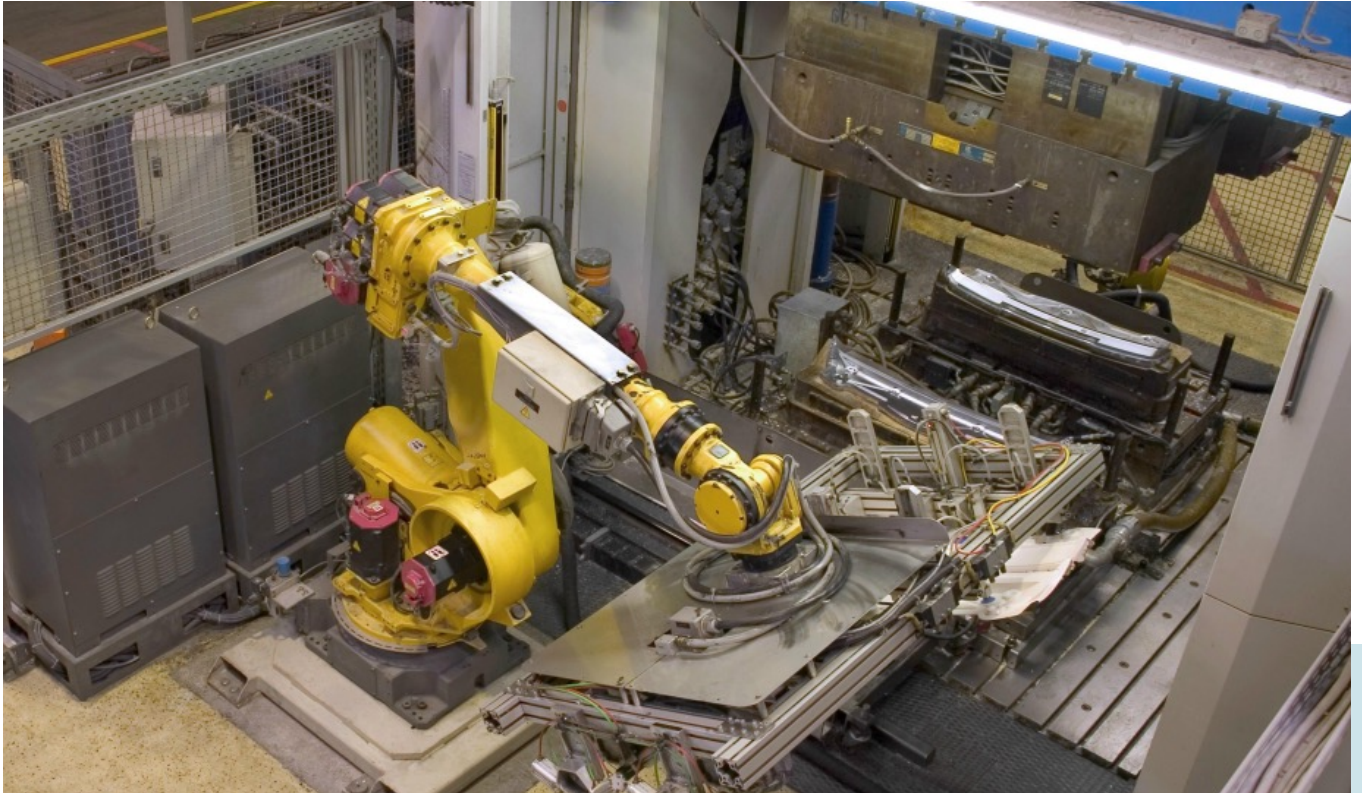

SMC/BMC Part Production

Sheet moulding compounds are transformed into finished parts by a processing technique known as compression moulding. These techniques of compression and injection moulding ensure part consistency within precise tolerances. A pre-weighed charge of material is placed into a matched metal tool which is located between two platens within a large press. The tool is heated up to 140-165°C depending on the formulation and other factors. Hydraulic rams then compress the material under a pressure of around 100 bar of projected area. It's the combination of heat and pressure that softens the SMC/BMC and forces the material to flow throughout the mould cavity.

The curing agent within the compound is stable at room temperature but is activated by the heat of the mould. Cure time depends on the type of resin in the matrix, the level of curing agent and the thickness of the component. Thick sections take longer to heat through and can generate excessive exothermic temperatures, which is why tool temperature is generally lower and the moulding cycle longer for thicker parts. Mould cycle time consequently depends on the size, thickness and complexity of the part, but a typical compression moulding cycle would be below two minutes. When the cycle is complete the tool is opened and the part removed ready for finishing operations such as de-flashing, machining and painting. Depending on production volumes, many of these stages mentioned are computer controlled and automated using robots.

*Compression
and injection
moulding ensure
part consistency
within precise
tolerances*

Compression moulding

Compression moulding is the transformation technique most commonly used for SMC and BMC moulding as the big presses can accommodate large platen sizes, making it ideal for large components ranging for train carriage panels to bath tubs. Stages in the process are as follows:

SMC raw material

SMC is normally supplied in rolls of 1.5m wide and weighing 350 – 1,500kg. For Class A panels, SMC has an optimum moulding window of around two weeks following manufacture. For non-appearance parts, larger moulding windows are possible.

Charge pattern

In high volume processes such as producing parts for automotive applications, SMC charges are normally prepared using an automatic peeling and slitting machine. The SMC is automatically peeled of its carrier film and cut into the appropriate pieces, which can then be stacked and arranged in the predetermined charge pattern. The weight of the charge is checked to ensure that it is within set-up tolerances. Where low to medium volume applications apply, like those found in the electrical industry, then these operations are generally done manually.

Charge placement

The charge is placed in the mould in a set position determined by the features of the mould, scribe lines marked in the tool or laser lines, to ensure a consistent charge placement. For high volume applications, robots are used to accurately place the charge. Handling and carrying of the SMC is normally by needle gripper techniques.

Moulding

The mould is closed with a fast approach speed followed by a controlled final closure speed. Variable pressure profiles can be used during the mould closure phase. A shear edge zone in the perimeter of the cavity enables air to pass through. The small amount of material that escapes through the sheer edge results in 'flash.'

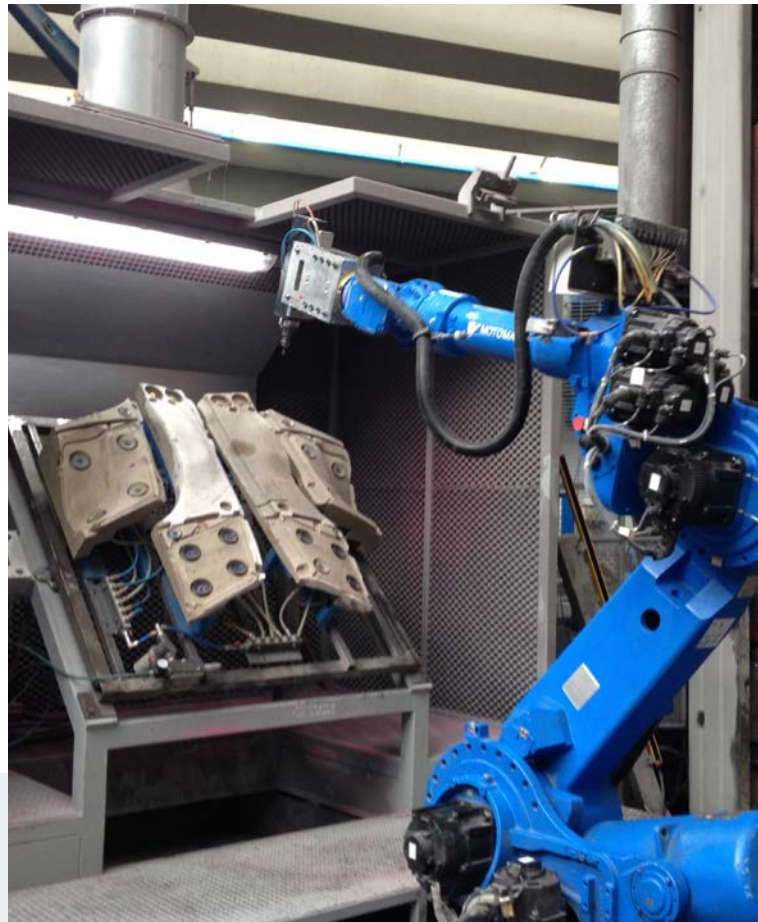

■ Robot changing a machine tool



■ Pick and place robot transfers spoiler mouldings

Finishing

De-mould and de-flash

The part is de-moulded by internal ejector pins. Larger parts can be handled using manipulators. Flash (normally 0.05 – 0.15mm) is normally removed by hand using abrasive paper although in large series production, robots normally do this job for speed and to ensure consistency in critical tolerances.

Routing and Machining

The moulded part then transfers to a machining centre where holes and apertures are cut out or drilled. Often this operation utilises CNC (computer numerical control) equipment that reads G-code instructions and drives the machine tool. The operating parameters of the CNC can be altered via software load programs. Robot machining centres and 5-axis routing machines are often used. Waterjet and laser cutting are also technologies increasingly being utilised by SMC/BMC moulding operations.

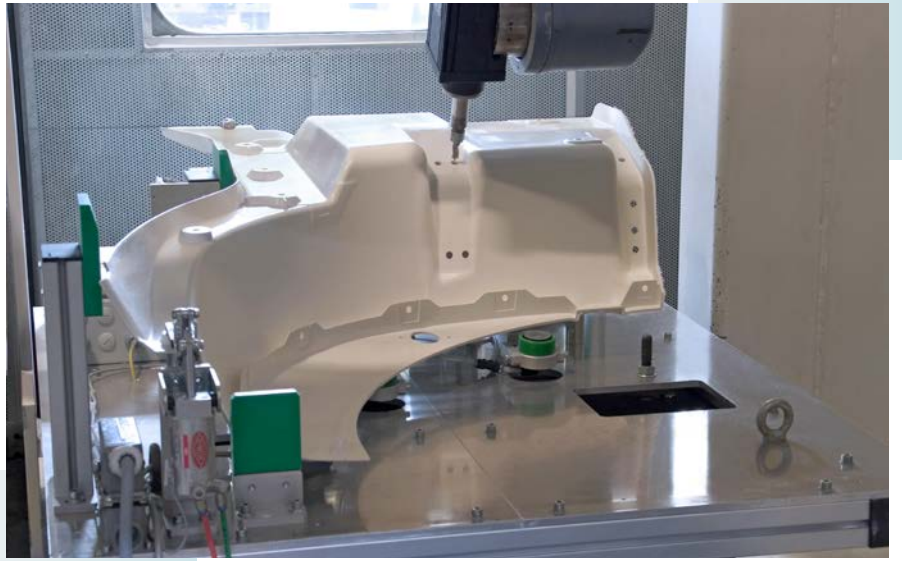

■ CNC drilling operation

polyurethane (PU) adhesives offer sufficient strength, even at elevated temperature, and sufficient low temperature elasticity to cope with vibration and the different thermal elongation of the bonded parts. As well as being tough they also show a much faster strength build as moisture curing adhesives, especially when moderate heat is used to accelerate the cure. Fixture times of down to 2 – 3 minutes are therefore achievable. For high heat requirements like automotive e-coating, epoxy adhesives give superior performance, but they are less flexible than PU and require closer gap tolerances. Large parts like railway carriage panels need a highly flexible adhesive to compensate for relative movement of the interface.

The choice of adhesive is also determined by process speed. For low series, long fixture times then a high elongation, moisture curing system is best. Faster high series production is

best suited to a two component high modulus system. Other parameters include: open time, cure response, cure conditions, rheology and colour.

Adhesive cure in the bonding fixture

It is important to fix the panels so they will not slide out of position during cure, while the adhesive is wet. Usually the bond fixture is designed to positively locate and hold the panels in the correct position until the adhesive has reached sufficient handling strength to allow safe further handling of the part. To reduce cycle times, in most cases heated fixtures are used. Typical temperatures range from 85 °C to 135 °C, with resulting fixture times of approximately 60 to 180 seconds. The heat can either be provided by electrically heated oil or steam heated aluminium moulds - or by hot air-impingement fixtures.

Bonding

Adhesives for bonding SMC/BMC

Special adhesives designed to bond composite to composite or composite to metals are now available. These are based on polyurethane, acrylic, epoxy or modified silicone (MS) polymer chemistry to meet most mechanical requirements. Nowadays, single component moisture curing adhesives and two-part adhesives are both in common use. Single component moisture curing adhesives (polyurethane or MS-Polymer based) offer the benefit of easy application with relatively low investment in the dispensing equipment, while two part adhesives show a much faster cure allowing shorter cycle times.

Adhesive Selection

In most cases the well balanced mechanical properties of structural



■ Hydraulic adhesive bonding fixture

Surface optimization and painting

De-mould and de-flash

SMC/BMC can be painted through conventional painting processes including baking ovens making them highly suitable and stable substrates available for automotive exterior body panel applications.

To ensure the best results and the best quality of the final part, it is important to consider that painting is not an operation that can hide defects. The complete process from designing, manufacturing (choice of the material, moulding, trimming, bonding) and painting (included washing and surface preparation) must be considered, because every step in the manufacturing process affects the next.

Painting of SMC/BMC parts

Before painting, automotive body panels in SMC and BMC are power washed to remove any lubricants, dirt and dust collected during moulding and normal handling of the panels.

Power washing is a multi-stage process. The first step is an ambient temperature water rinse. This is followed by a chemical wash at 50-60°C for 1-2minutes, then a hot water rinse at 50-60°C for 1-2minutes, before a second ambient temperature water rinse. De-ionized water rinse at room temperature is then applied followed by blow-off and drying-off oven at 90-120° for about 30 minutes.

On-Line painting procedure for parts on the assembled on the Body-In-White consists of E-coat treatment, oven cure at 190-200°C, followed by primer deposition, sealing, base coat and clear coat deposition. These require drying and curing treatments at temperatures between 120-165°C.

Metals parts need E-coat (ELPO or phosphate) treatment for corrosion protection. Of course, SMC and BMC parts don't rust and therefore require no corrosion protection, but can be processed with steel through phosphate coatings and electro deposition primer operations.

Typically when primed, SMC and BMC panels are processed with Body-in-White Parts since the corrosion protective coatings will not adhere to the SMC and BMC parts. In-Line painting is usually preferred when space is available in the paint line. In this case SMC/BMC parts are assembled on the Body-in-White after E-coat treatment and then painted as described for On-Line process. For small volumes parts Off-Line painting is usually preferred.

Parts are often painted with a two-pack PU paint and oven cured at 80-100°C. The drawbacks of Off-Line painting is that colour and surface appearance have to be precisely matched and matching the process adds extra costs.

Special finishes

All Class A panels are primed and top-coated with conventional primers and paints. The most commonly used are water based. Solvent based coatings are still used but gradually they are being substituted by water based systems for environmental reasons: water based coatings can reduce VOC emission in the painting lines by 45% compared to solvent based paints. New emerging technologies such as powder based and UV curable coating have also proven to be effective with SMC and BMC substrates.



*The painted
finish of a Class
A SMC panel is
indistinguishable
from a painted
steel or
aluminium panel*



In-mould coating (IMC)

In-Mould Coating (IMC) is a single component product designed to enhance the surface of SMC mouldings in terms of functional and cosmetic properties. IMC works by filling porosities, reducing sink marks and providing a primer-like or topcoat-like coating. IMC is generally included as part of the moulding cycle in the production of compression moulded SMC exterior automotive body panels.

The most common IMC processes utilise a reduction in pressure after

an SMC panel is sufficiently cured to allow the high-pressure injection of IMC. In some cases the mould is actually opened a small amount. After the material enters the mould (on the Class A surface side of the part), pressures are increased again to force the IMC into the extremities and higher elevations of the mould cavity.

Where IMC is considered as a treatment for a Class A parts, moulds should be designed to have proper orientation of the mould cavity to allow IMC to flow to the part extremities.

The IMC nozzle also needs to be located where it will not leave a defect on the appearance surface. Even if IMC is not specified for the initial program, taking these precautions will allow IMC to be added at a later date if porosity becomes a processing concern. While many existing moulds can be retrofitted to accept IMC, the critical factor is determining the location of the injection nozzle and evaluating whether the cavity orientation will allow full coverage of the Class A surface.

Other moulding techniques

Injection Moulding

Injection moulding is one of the main transformation processes used in the plastics industry, and increasingly for thermosets. Virtually all sectors of manufacturing use injection moulded parts; the flexibility in size and shape possible through use of this process have consistently extended the boundaries of design in plastics, and enabled significant replacement of traditional materials thanks to light weighting and design freedom. BMC electrical components and domestic appliance parts are generally injection moulded. Intricate parts can be produced with a glossy surface finish. Special grades of SMC are also now

available for the injection processes. BMC for injection (and compression) moulding is normally supplied in pre-weighed charges or 'slugs'. The injection moulding machine consists of a heated barrel equipped with a reciprocating screw (driven by a hydraulic or electric motor), which feeds the heated material into a temperature controlled split mould via a channel system of gates and runners. The screw also acts as a ram during the injection phase where the material is forced into a mould tool.

Injection / Compression

There are now several innovative proprietary processes for moulding

SMC/BMC that combine the benefits of compression moulding, in terms of maintaining higher level mechanical properties, with the faster cycle times of injection moulding.

In-Mould Coating enhances the surface of SMC mouldings in terms of functional and cosmetic properties

A black and white photograph of an industrial factory floor. In the foreground, there is a metal safety railing with a wire mesh. Behind it, various pieces of industrial machinery are visible, including what appears to be a large lathe or mill. The background shows more of the factory structure with pipes and overhead lighting. A large blue semi-transparent graphic overlay covers the right side of the image, containing the chapter title and a quote.

CHAPTER 5

QUALITY

“ SMC/BMC:
quality
throughout
the chain

System thinking and quality management throughout the process chain

In the 1970s, SMC was a rather labour intensive process dependent on levels of individual craftsmanship for quality and consistency. Nowadays SMC manufacture, moulding and finishing is an industrialised and largely automated process. But producing a high quality part takes more than the right material and moulding process. Proper mould design and construction is critical. Success also depends on a production plan, a quality plan and a part design that combines processing requirements with end-use properties.



■ Fully monitored SMC line used for product development and process quality improvement.

Process data analysis, computer controlled process management, implementation of SPC (Statistical Process Control), and visualisation techniques throughout the entire process chain ensure measurability and optimisation. Members of the European Alliance for SMC/BMC operate high performance quality standards like ISO TS 16949 and/or ISO 9001:2000.

What makes a quality SMC part?

- Part design considering end-use, (e.g. two shells for Class A, mouldability)
- Mould design, mouldability, shear edge, heating, vacuum assist, In-Mould coating
- Defining optimal SMC properties then selecting raw materials to give the optimal properties
- Consistent SMC weight distribution (resin/glass fibre ratio)
- Maturation, storage and shipment of SMC
- Defining all processes along the chain
- Mould construction, chrome plating
- Construction of devices, accessories
- Mould break-in phase and possible modifications
- Training of personnel
- Using the appropriate press and establishing parallel controls, speed, pressure
- Post moulding operations – de-flashing, drilling, machining
- Bonding operation, adhesive and fixture
- Priming and top coating
- Storage and shipment of the parts/ assemblies

*SMC manufacture,
moulding and finishing
is an industrialised
and largely automated
process*

OEM quality requirements

- Excellent surface quality (e.g. no waviness, fibre pattern, orange peel, sink marks, bond read-through or paint pops)
- Online paintability: suitable for paint baking > 190°C
- No emission of dangerous by-products, no styrene emission, low carbon emission, no bad odours
- Precise dimensions, no warpage or distortion
- Short cycle time for maximum productivity
- Consistent part quality
- Low density for automotive OEM
- Part and process simulation
- Fit-for-purpose part design
- Well understood mould and process technology: total system approach to reduce costs

Quality in the design & planning phase

A good moulding that meets the OEM's requirements, will be based on fit-for-purpose design, production planning and quality planning.

A successful product is based on a part design matched to processing parameters. A good part design must be turned into an excellent mould since the part can only be as good as the mould and material it's based on. Long- term operating quality should be the goal and not short- term cheap mould thinking.

Mould steel quality, air evacuation, temperature control (absolute and distribution), shear edge quality (hardness, smoothness, geometry), surface quality, draft and ejection system: all have a decisive influence on mould operation and part quality. A good part released from the mould needs accurate post moulding operations like deflashing, drilling, milling, bonding, painting and assembly before it is shipped to the customer. All these steps have to be carefully considered during the planning phase.

Moulder quality requirements

- Consistent SMC sheet quality
- Consistent fibreglass content, fibre distribution and orientation
- Consistent thickening
- Consistent impregnation
- No dry edges
- Easy to handle packaging
- Simple warehouse conditions: advance quality information on delivery, exact delivery schedule

Quality in the SMC manufacturing phase

This complex process requires great care to avoid potential mistakes. So when making high quality SMC, a good resin paste is an essential starting point as there can be no compromising on accurate formulations and good raw materials - all handled and formulated in the right way.

The so called thickening of SMC, involving a thousand fold increase in the viscosity of the resin paste, controls the flow and moulding behaviour of the part. It begins at the SMC machine and finishes in a temperature controlled maturation room a couple of days later.

Glass fibres are added on the SMC line - together with two layers of resin paste, which determine the sheet weight and glass content. Sheet weight is essential for moulding consistency and fibre content influences the weight, strength and rigidity of the moulded part. Modern SMC plants are equipped with computer controlled installations for:

- Metering and mixing the raw materials
- Controlling paste consistency and volume
- Glass content control
- SMC sheet weight control

SMC manufacturing process

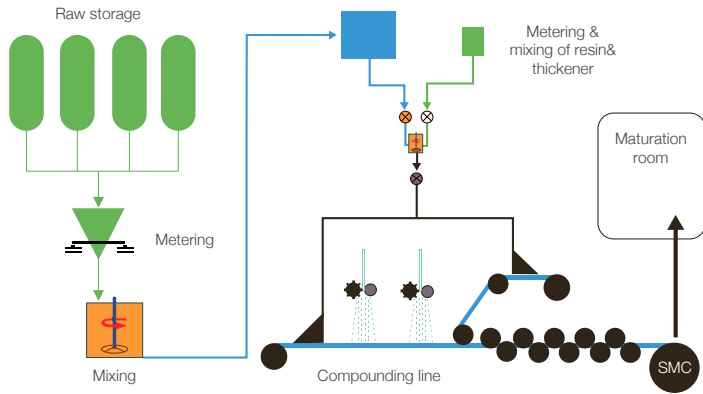

Control of resin paste sheet weight

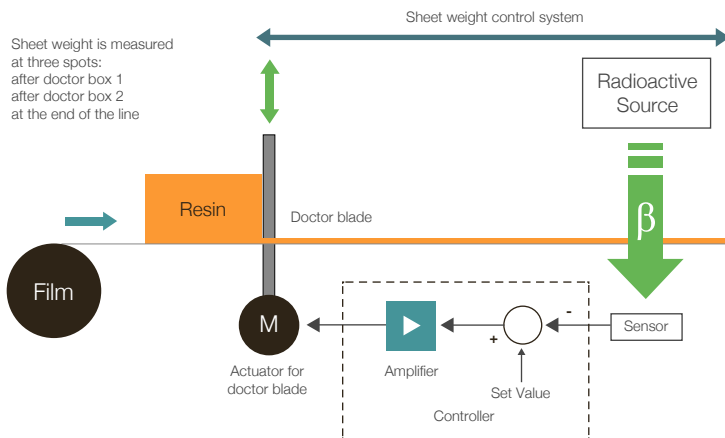

Glass content control

Mass flow of glass fibres is known and given as set value.
 Mass flow of fibres = rotating speed of cutter roll x number of rovings x Tex per Roving
 Fibre content in % = $(\beta_3 - \beta_2 - \beta_1) / \beta_3$
 This gives two measured parameters to calculate the fiber content

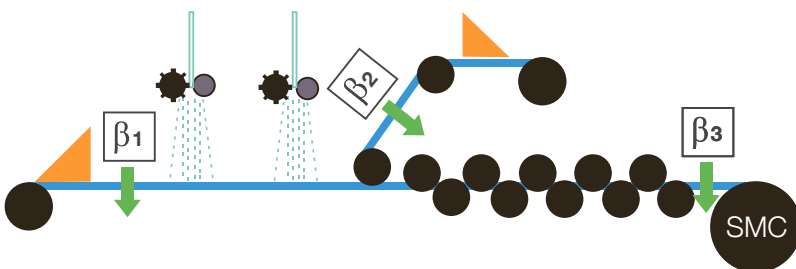

Quality in the SMC moulding phase

The SMC moulder is responsible for proper mould maintenance and is required to follow the moulding instructions in a precise and disciplined way.

At the moulding level, the essentials for consistent quality are a good mould and high quality SMC. Thickening, sheet weight, and fibre content are the most important material properties at this stage as they control the material flow and moulding behaviour. Material flow lasts just a few seconds before chemical cross linking and curing sets in to harden the part.

Speed of press closure depends on hydraulic rams which need to also be properly maintained. All these process parameters are inter-dependent creating a network that influences the quality of the final part. It is essential to find the optimal parameters at mould break-in and maintain these parameters throughout the life of the project.

Quality is the result of system thinking and rigorously applied quality management throughout the entire process chain. Members of the European Alliance for SMC/BMC represent companies along the value chain from raw material suppliers to moulders. We therefore have a lot of expertise on all aspects of quality management within the Alliance. If you have a specific question, please contact the SMC BMC alliance.

Consistent quality means maintaining consistency throughout the production cycle

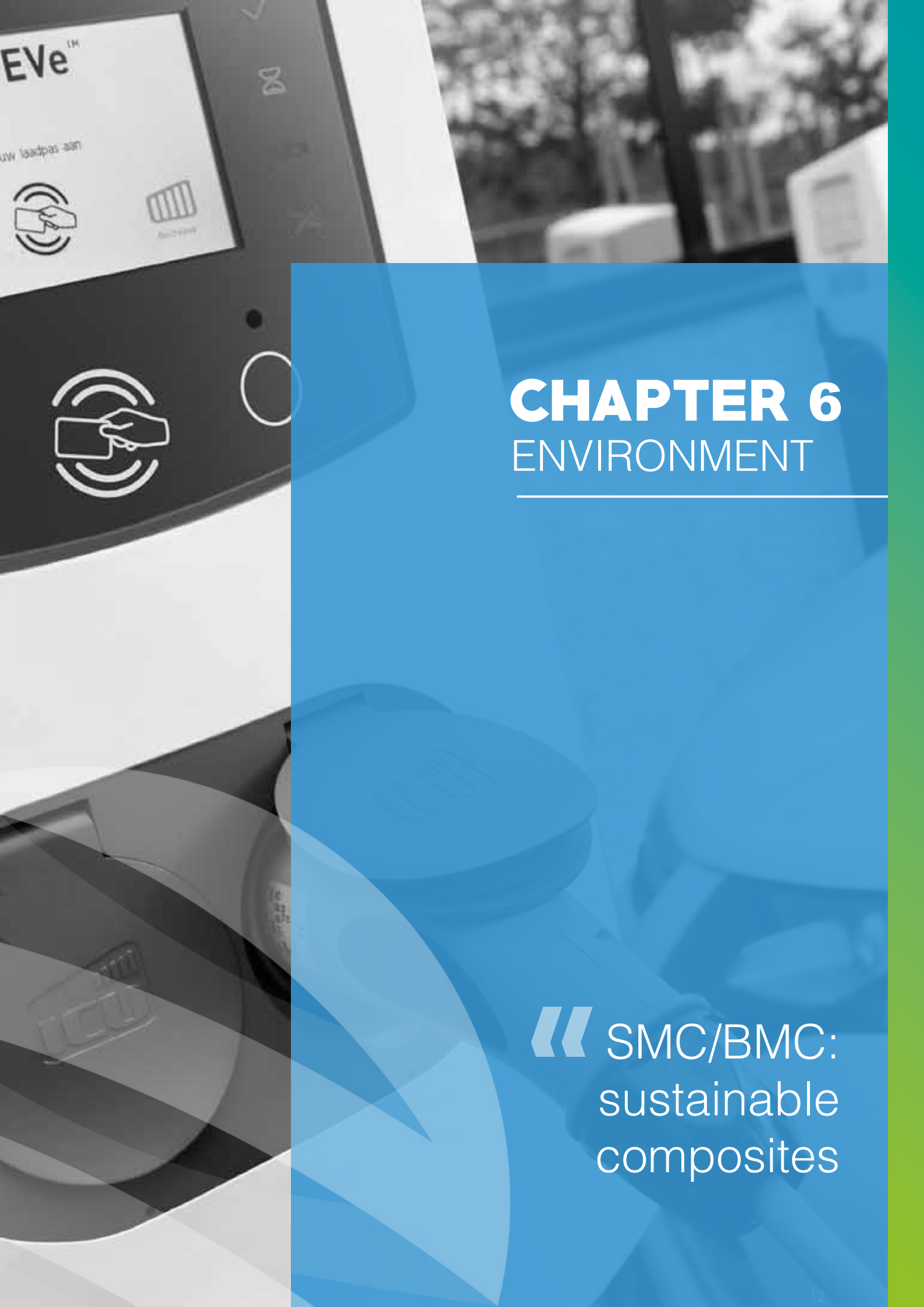

CHAPTER 6

ENVIRONMENT

« SMC/BMC:
sustainable
composites

Environment & Life Cycle Analysis

Life cycle analysis versus steel and aluminium

The SMC / BMC industry has come a long way since the material first became commercialized in the 1960s: product properties, increased part performance, lower system costs and validated recycling routes have made SMC/BMC a much more attractive material. New selection criteria now include LCA (Life Cycle Analysis) and sustainability analysis. This takes into account factors like sustainability of the industry, depletion of natural resources, environmental considerations / carbon footprint, legislation and public opinion. How a company deals with sustainable development is becoming an important factor, which is why the Alliance took the initiative to finance a project investigating Life Cycle Analysis (LCA) for SMC parts compared to metals and plastic material (PA6).

In LCA, the environmental impact that a product or process creates from cradle to grave is assessed. This covers the whole process from raw material extraction through use of the specific part to post-use disposal or recycling.

Environmental Impact Analysis

To get a true picture of the performance of SMC/BMC we need to compare the material's properties versus competitive materials like steel, aluminum and thermoplastics. The benchmarking graphs that follow show how well SMC/BMC compares to metals and other plastics.

On behalf of the European Alliance for SMC/BMC the Life Cycle Simulation GmbH completed a study which investigated the life cycle of different materials, i.e. SMC, thermoplastic, aluminum, steel. The results of this study are documented with a mathematical model and can be used by the alliance members.

The European Alliance for SMC/BMC carried out a Peer Review according to ISO 14044. The study was conducted through Life Cycle model built-up for generic panel materials of a mobile (e.g. Automotive decklid) and a stationary application (e.g. E-charger unit for E-cars). A cradle-to-grave analysis was then applied to evaluate the properties of these materials.

The LCA is a model with a reference flow that can be used to model specific functional units and is suitable for identification of improvement potentials within the life cycle of SMC materials, such as a weight and layer thickness.

In a nutshell the LCA study considered the following aspects:

- Life Cycle analysis (cradle-to-grave) of a generic technical part (panel) with the reference flow of 1m² surface (one-sided);
- Materials considered: SMC, PA6-30 (30% glass fibres), aluminum, steel;
- Applications used: mobile (automotive, trucks) and stationary device (technical);
- The LCA data basis for the study was published and the information for steel, aluminum and PA6 production and their recycling processes was peer reviewed. No specific steel or aluminum materials with alloys were taken into account. The SMC material was investigated with the support of available industry information from company members of the European Alliance for SMC/BMC. Information about additional materials was provided by LCS Life Cycle Simulation GmbH;
- The software based Life Cycle model enabled the following tasks:
 1. Identify important parameters within the cycle of materials;
 2. Be flexible to include additional specific information (e.g. for panels) or consider changes in boundary conditions (e.g. electricity mix for production processes, fuel for use phase, new production or assembly processes, etc.).

Source:
**LCS Life Cycle Simulation
GmbH: www.lcslcs.de**

System boundaries of ecological investigation

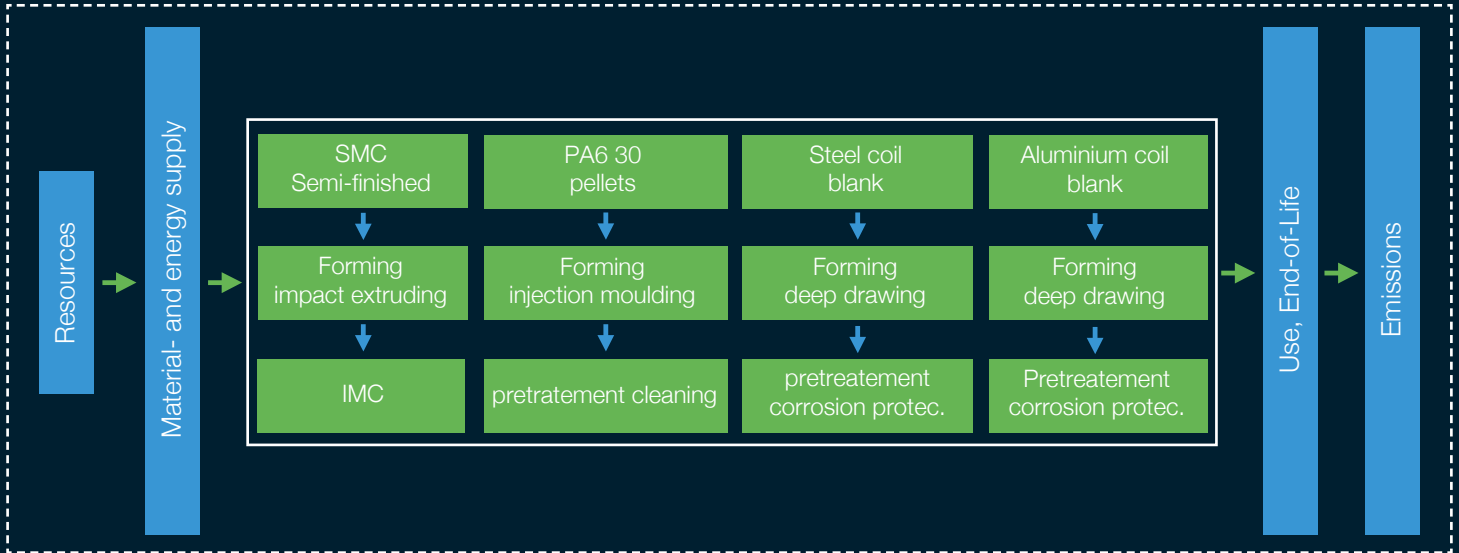

■ *The above flow diagrams set out the boundary conditions for the mobile application.*

PARAMETER LIFE CYCLE INVENTORY	UNIT	DESCRIPTION	EXAMPLES
Primary Energy (PE)	MJ	Total of heating values of used non regenerative and regenerative energies	Crude oil, natural gas, hydro power, etc.
Abiotic resource depletion (ADP)	Kg Sb-equiv.	Use of non regenerative resources	Crude oil, metal ores
Green house warming potential (GWP)	Kg CO2-equiv.	Emission to air which influence the heat balance of the atmosphere	CH4, CO2
Photochemical oxidants creation potential (POCP)	Kg Ethene-equiv.	Emission to air which act as ozone creators at ground level	HCS
Acidification potential (AP)	Kg SO2-equiv.	Emissions to air which create acidification of rain water	NOx, SO2
Eutrophication potential(EP)	Kg PO4-equiv.	Overfertilisation of water and soil	P- and N- Compounds

■ *Parameters of LCA study.*



Results/Base scenario automotive application

- The biggest environmental impact in the life cycle of an automotive part is recorded during its use phase due to fuel consumption if the total part weight is taken into consideration. If the weight difference is the base for the comparison, the production and End-of-Life (EoL) process can have a bigger environmental impact;
- The most important categories with regard to EU27 reference factors are resource depletion (ADP), climate change (GWP), summer smog (POCP) and acidification (AP);
- The eutrophication (EP) has less impact;
- Significant technical parameters are weight of part and rate for material and thermal recycling;
- The pre-treatment and corrosion protection for steel and aluminum process has a low environmental impact, these processes are most efficient during painting for light-weighted vehicles.
- SMC reduced up to 40% energy use, 47% CO2 emissions, 60% ozone and 25% acid rain water vs. competing materials in mobile applications.

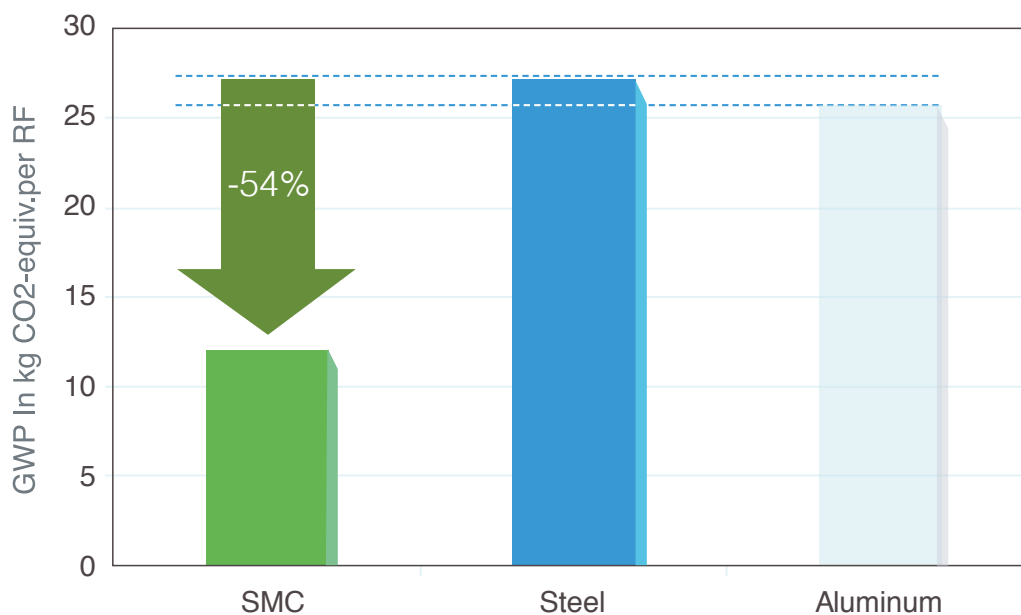

Results/Base scenario stationary device

- The biggest environmental impact in the life cycle of a stationary part is the production and use phase but mainly for steel and aluminum;
- The most important impact category with regard to EU27 reference factor is summer smog (POCP) where SMC has significant advantages vs. traditional materials;
- The eutrophication (EP) category has less impact;
- Significant technical parameters are weight of part, number of maintenance operations and rate for material and thermal recycling;
- The pre-treatment and painting for steel and aluminum process have a high environmental impact, because of high energy intensity and significant high volatile organic compounds (VOC) emissions;
- SMC reduces up to 50% Energy use, CO2 emissions, ozone and acid rain water vs. competing materials.
Example of stationary device: E-charger unit made in SMC composites.

Front Cover
SMC: Glass fiber reinforced polyester
High gloss white (unpainted)

Back Cover
SMC: Glass fiber reinforced polyester
Textured grey (unpainted)

- Non-painted SMC
- Weight 5,9 kg
- Class A
- White
- High Gloss

- Non-painted SMC
- Weight 4,76 kg
- Semi-Structural
- Grey
- Up to 8 mm thickness

- Total SMC of 10.6 kg
- 2,45m2 SMC functionality (=reference Flow)
- White and Grey

LCA (Cradle-to-Grave) for Stationary equipment (30 yrs) (Normalized to Steel)

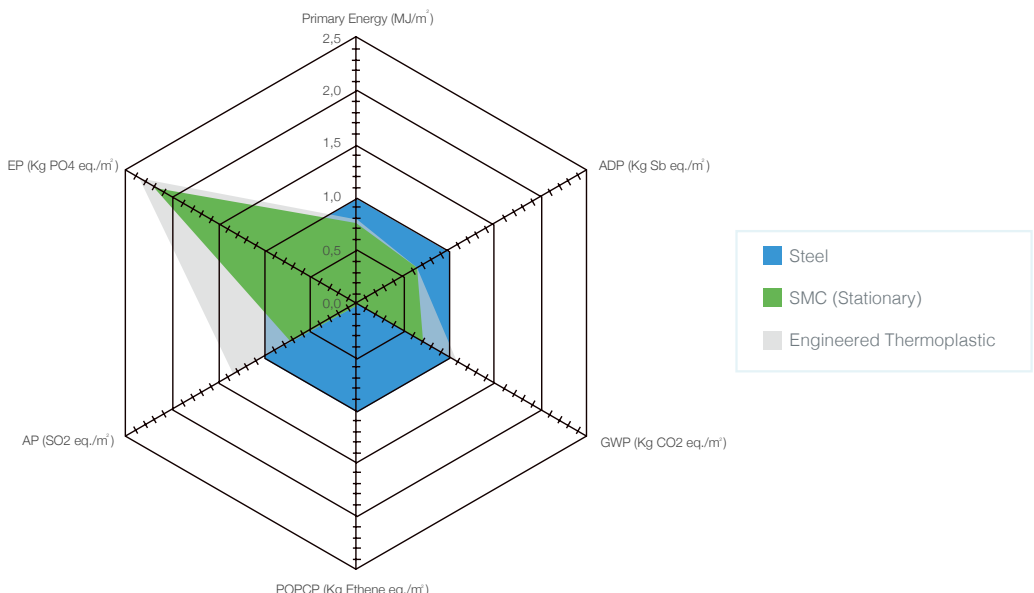

Recycling Made Easy

Composite Solutions that Last

SMC/ BMC materials provide solutions for mechanical strength and protection in many market segments such as transportation, electrical, building and infrastructure, industrial and energy. These materials have a track record of providing useful benefits including high durability, mechanical performance, design freedom, low weight, and ease of manufacturing.

Components in SMC/ BMC can be easily recycled. This chapter provides an insight into the established recycling routes for SMC/BMC materials, and their positive impact on the environment.

Recycling of SMC/BMC makes business sense and it is environmentally beneficial

The recycling of glass fibre reinforced thermosets has been studied extensively since many years. Fundamentally, three recycling technologies have been researched and yield potential waste management solutions: material recycling, chemical recycling and co-processing. Co-processing composites through the cement kiln route is considered the best recycling option (Reference: Joint industry position paper on Glass fibre reinforced thermosets: recyclable and compliant with the EU legislation", I (June 2011) by EuCIA, ECRC, EuPC, Cefic).

The recycling of glass fibre-based SMC/BMC regrind through co-processing in cement kilns is proving to be highly cost effective, is generating valuable materials, and is helping to improve the Ecological Footprint of cement manufacturing. For these reasons, this recycling route is becoming increasingly popular across Europe.

Co-processing is the simultaneous use of composite regrind as raw material and as a source of energy in cement manufacturing, to replace natural mineral resources (material recycling) and fossil fuels such as coal, petroleum and gas (energy recovery). In this process, the composites regrind used for co-processing is both an alternative fuel and raw material.

Composites recycling through Co-processing: technically possible and cost effective

Glass fibre thermoset composite parts - originating from part manufacturing or end-of-life components - are cut in smaller sections and processed into small chunks. The resulting regrind is combined with other feedstock materials into an input stream with consistent composition and caloric value.



■ Typical regrind



Disclaimer (this applies to the Recycling pages)

This publication is intended for guidance only and provided in good faith. While the information in this document is accurate as far as the authors are aware, no representations or warranties are made with regards to its completeness and no liability will be accepted for damages of any nature whatsoever resulting from the use of or reliance on the information contained in the publication. Full or partial reproduction of the information in this document is allowed, but only when mentioning EuCIA as the source and on the condition of informing EuCIA through info@euCIA.eu.

■ Composite recycling in process.

FACTS	BACKGROUND
Composites are recyclable	Recycling through co-processing in cement kilns has been technically and commercially demonstrated. Today, companies are setting up logistics and supply chains for ensuring proper handling of regrind and quality consistency of cement manufacturing.
Thermoset composites cannot be easily converted into their original raw materials	Therefore, recycling through co-processing in cement kilns is increasingly used for managing composite regrind because of its technological potential, environmental benefits and cost effectiveness.
Composites can contribute significantly to the reduction of Eco-footprint and CO2 Emissions	Composite materials are designed to provide mechanical strength, chemical resistance, and durability. Consequently, by definition they cannot be easily re-converted into their original raw materials. Composite structures tend to have a better Eco-footprint compared to their equivalent in traditional materials like steel or aluminium. Reduced emissions through lower weight in transportation, easier installation and reduced maintenance in construction, and continuity of operation in industrial applications all contribute to this great performance.
Co-processing in cement kilns is clearly different from incineration	After their useful life saving energy and helping to reduce Eco-footprint in many applications, composite regrind can reduce Eco-footprint and CO2 emissions of cement manufacturing. Co-processing glass fibre thermoset composites regrind allows the inorganic fraction to act as valuable raw material, while the organic fraction acts as efficient fuel for the calcination process.
Composite recycling though co-processing in cement kilns is compliant with the EU legislation	In the incineration of composite regrind, the organic fraction is not re-used, and therefore incineration cannot be considered recycling. In addition the heat generated in incineration cannot be used as efficiently to reduce the amount of fuel required. Recycling through co-processing in cement kilns is fully compliant with the European Waste Framework Directive (WFD) 2008/98/EC providing viable waste management route for the composites industry. Co-processing is both recycling and energy recovery.

European recognition for composites recycling

Recently the European Commission released a Guidance document on the interpretation of Waste Framework Directive WFD 2008/98/EC. The document is intended to help national authorities and companies interpret the Directive.

Among other specifications, co-processing in cement manufacturing is included in the definition of waste prevention and of waste-management options, both under recovery and recycling (Chapter 1.4). The Guidance notes that:

“In certain production processes such as co-processing, waste can be used in an operation combining two waste management recovery options at the same time. The energy content of the waste is recovered (R1 operation) as thermal energy, thus substituting fuels, while the mineral fraction of the waste can be integrated (hence recycled) in the matrix of the product or material produced, e.g. cement clinker, steel or aluminium [...]” (Subchapter 1.4.5).

Source: Guidance on the interpretation of key provisions of Directive 2008/98/EC on waste, European Commission, June 2012

The process of cement manufacturing

In the cement manufacturing process several raw material fractions are combined with an energy source and heated up to 1450 °C for making cement clinkers. The clinkers consist of four basic oxides in a specific proportion: calcium oxide (65%), silicon oxide or silica (20%), aluminium oxide (10%) and iron oxide (5%). Gypsum (calcium sulphate) and possibly additional cementitious compounds (such as blast furnace slag, coal fly ash, natural pozzolanas, etc.) or inert materials (limestone) are added to the clinker. All constituents are ground into a fine and homogenous powder called cement.

By the very nature of this process, a fair amount of CO₂ is generated. The Cement industry has made significant steps to improve sustainability and the carbon footprint by replacing the traditional fuels such as oil, gas and coal with alternative fuels in clinker production.

Glass fibre thermoset regrind is an ideal raw material for cement manufacturing. The mineral composition of the regrind is consistent with the optimum ratio between calcium oxide, silica, and aluminium oxide. Additionally, the organic fraction supplies fuel for the reaction heat, right at the spot where it is needed most.

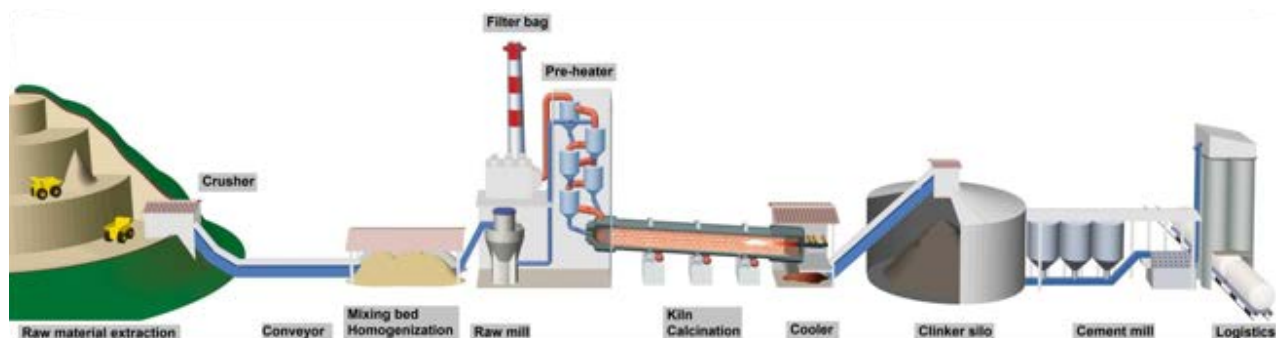

■ Typical cement manufacturing process (Courtesy: Holcim)

Life Cycle Assessment of Clinker Manufacturing

Together with the Swiss Federal Institute of Technology (ETH) in Zürich, Switzerland, a detailed LCA model has been developed describing the clinker manufacturing process. The objective was to better understand the improvements that can be made in terms of carbon footprint by replacing the traditional fuels in clinker production.

Key assumptions for this specific case study on composite regrind co-processing in cement manufacturing are listed below:

KILN TECHNOLOGY	
Kiln type	Precalciner
DeNOx installation	SNCR (Selective Non Catalytic Reduction)
Dust filter	E-Precipitator
Composite regrind characteristics	
Calorific Value	15.3 MJ / kg
CO2 emission factor	87.4 kg / GJ
Carbon Content	36.6%
Ash content	46.1%
Electricity consumption for waste preparation	0.04 kWh/kg
Transport distance	119 km
Fuel substituted	
Coal	26.05 MJ/ kg

Reduced Ecological Footprint of cement by using composite regrind

By using Composite regrind in co-processing a significant reduction of CO2 emission of the clinker manufacturing process can be obtained. Depending on the quantity of composite regrind included and the specific cement plant technology, the reduction can be as high as 16 %.

Significant Emission Reduction
 0.9 kg CO2-eq/kg composite
 1.8 kg CO2-eq/kg resin

Emission reduction using composite material

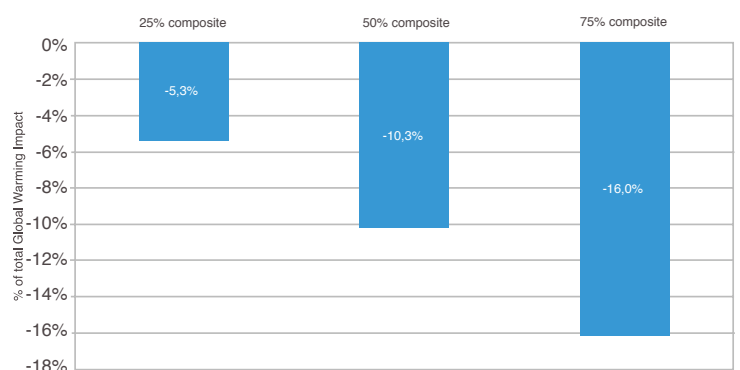

Fig. 8: Reduction of CO2 footprint for the specific clinker manufacturing with composite regrind, in comparison to a process without alternative fuels based on coal as fuel (Courtesy: Holcim)

The transportation of composite regrind from its source to the cement kiln will obviously influence the calculation of the Eco-footprint. Nevertheless, it has been confirmed that the impact of transportation is fairly limited on the total CO2 footprint of the clinker manufacturing process.

Transport sensitivity

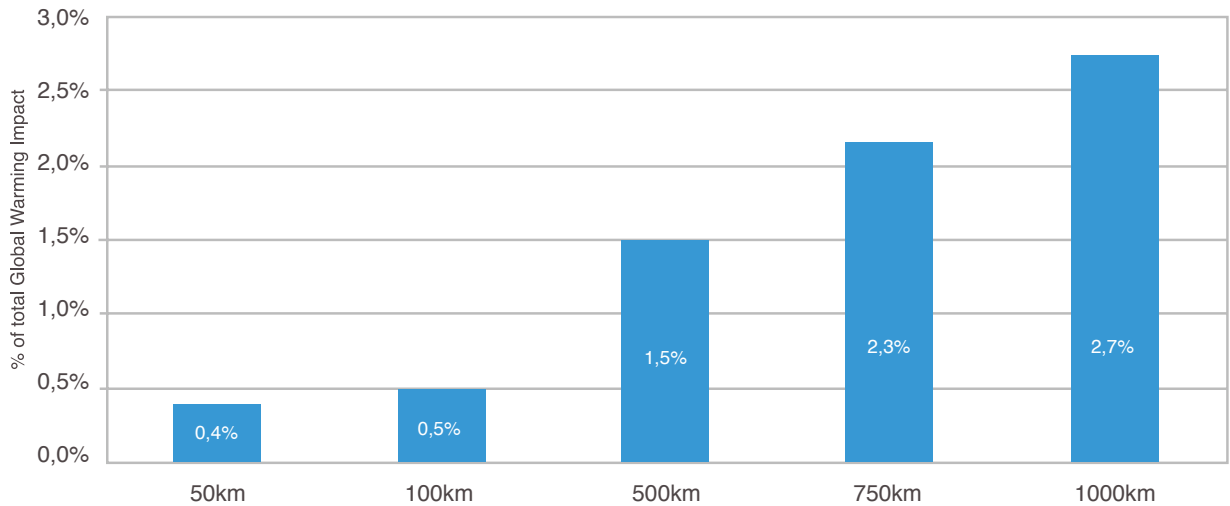

Fig. 9: Contribution of CO2 footprint associated with composite regrind transportation as a percentage of the total CO2 footprint for the specific clinker manufacturing in this brochure, as a function of transportation distance (Courtesy: Holcim)

Conclusion

The conclusion of the study showed SMC with an improved LCA profile compared to steel and aluminium alternatives. Future developments in weight reduction and functional integration while keeping cost under control enable to position SMC as material for current and future generations.

SMC composites are durable and can save 30% to 50% of CO2 emissions during the life-cycle compared to steel



A white Iveco truck is shown in an industrial setting, possibly a port or factory. The truck is the central focus, with its front and side visible. The background features complex industrial structures, including cranes and scaffolding. A large blue semi-transparent overlay covers the right side of the image, containing the chapter title and a quote. The truck's front grille has the 'IVECO' logo, and the word 'STRALIS' is visible on the side of the hood. The truck is parked on a paved surface. The overall scene is in grayscale, except for the blue and green accents of the overlay.

CHAPTER 7

APPLICATIONS

“ SMC/BMC:
ideal solution
for many
industries

SMC/BMC

Versatile Materials

Steel is steel, aluminium is aluminium but SMC/BMC is whatever you want it to be! The unique capabilities for customization in formulation and total freedom in part design have been an innovation for many industries. In this chapter we look at the principal market segments of Automotive, Mass Transportation, Electrical and Building & Construction, showing typical SMC/BMC applications and highlighting the principal benefits that these versatile materials offer in each segment.

Principal

application segments

- Automotive: cars, trucks and other commercial and agricultural vehicles
- Mass transit: trains, trams, light railways and monorails
- Electrical & electronic: housings, fuses and switchgear etc
- Building & construction: civil engineering and household fixtures
- Domestic appliances: coffee machines, toasters, irons oven handles etc
- Sanitary: bathroom suites and hygienic surfaces



Benefits of SMC/BMC in automotive applications

DESIGN FREEDOM :

- Design freedom (complex geometries and integration not possible in metals)
- Function Integration (e.g. antenna systems can be hidden between inner and outer panel shells)
- Parts Integration (e.g. single technical section can replace >20 individual metal parts)
- Class A surface with same appearance as steel parts
- Mass coloured
- SMC / steel / aluminium hybrids are fully compatible

SYSTEM COST :

- System cost saving potential compared to steel, with lower tooling costs for shorter series
- Customization and speed to market are easier and faster with SMC/BMC
- On-line paintability

PERFORMANCE:

- Weight savings with excellent strength/stiffness
- Permeability of electronic waves for antenna systems
- Coefficient of Linear Thermal Expansion (CLTE) comparable to steel and aluminium
- Retention of properties after paint and thermal treatments
- Excellent sound dampening properties, substantially better than aluminium
- Engineered crash performance
- Resistance to corrosion from hot oil, petrol, coolants, brake fluid, glycols or road salts
- High heat resistance makes SMC/BMC suitable for underbonnet parts, headlamp reflectors and sunroof frames and assemblies

1. AUTOMOTIVE

For producers of cars, trucks, buses and agricultural vehicles, SMC/BMC offers many advantages such as parts consolidation, corrosion resistance, low weight and lower capital investment for shorter series production.

Progressive advances in quality consistency, automation and industrialisation throughout the SMC/BMC value chain - coupled with improvements in Class A surface finish - have now made this family of materials a popular choice for visible panels in higher series vehicles. There is also potential for significant system cost savings over steel. SMC/BMC also has many applications under the hood such as engine oil sumps, valve covers and front ends.

Opposite is a brief summary of the principal benefits that apply - to a greater or lesser extent – in every automotive application.

Commercial and agricultural vehicles

Truck building was the first automotive sector in Europe to fully recognize the commercial potential of SMC as a structural material for body panels. Pioneering independent truck builders were using an all-SMC truck cab as long ago as the early 1970s. Design flexibility and reduced tooling costs compared to steel, made SMC an attractive and viable alternative for their low series requirements. They also found that SMC panels absorbed sound and vibration better than metals.

These days most major truck OEMs – as well as producers of coaches, agricultural vehicles and earth moving plant and equipment - utilise SMC/BMC for external panels, as well as for under-hood and semi-structural parts.



Applications

Typical truck body panels and components :

- Fenders
- Roofs
- Air-foils
- Hoods
- Truck cabs and sleeper extensions
- Truck steps
- Truck grilles and grille opening panels
- Doors
- Spoilers





Passenger cars

Class A body panels

SMC/BMC has been used for over 30 years by automobile producers for hoods, trunk lids, fenders, spoilers, tailgates and even complete car bodies.

Improvements in Class A surface finish and paintability over recent years have seen SMC/BMC volumes grow substantially. What was once seen as a material for niche vehicles such as sports cars, SUVs and MPVs, is now a

mainstream material that is used in a whole range of applications on both short and high series models.

Lower system costs and integration of parts and functions are two of the main drivers behind the growing use of SMC/BMC, especially in applications such as the decklids. SMC/BMC decklids are now found from economy models to range topping limousines.

SMC/BMC engine components

Oil sumps, valve covers and engine under-covers

These are all applications where high heat and chemical resistance are important. SMC/BMC components used in these applications have to withstand hot engine oil, break fluid and other corrosive media. Good noise attenuation also means that SMC/BMC parts can result in a quieter running engine. Unlike metals, SMC/BMC is a good heat insulator which means that engines reach operating temperature quicker - improving efficiency and saving fuel.



Applications

Typical SMC/BMC
car exterior applications :

- Fenders
- Roofs and roof inner compartments
- Hoods
- Tailgates
- Decklids
- Doors
- Spoilers
- Scuttle panel
- Pick-up floor pan
- Wheel arches
- Wheels

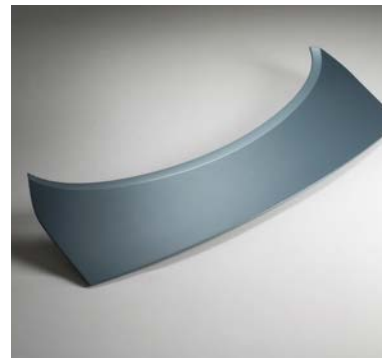



Carbon fibre SMC for ultra low weight

The significant weight reduction when using a carbon fibre reinforced SMC (CF-SMC) vehicle part, also allows an additional reduction in the weight of connecting and supporting components and fixings. When designing parts, it is important to know the flexural or tensile stresses that the part will encounter. Because of the higher strength of CF-SMC, wall thickness can typically be reduced by an additional 38%, down to less than 1.5mm. So, based on equivalent flexural stiffness, there is a potential weight saving of over 55% where CF SMC is used instead of standard SMC. Cure cycle time is as fast as regular SMC (<3minutes).

- *Semi-structural Scuttle panels moulded from CF SMC for high performance sportscar*



SMC/BMC for under-the-hood structural and semi-structural parts

As well as exterior body panels, SMC/BMC also has many applications under the hood. Typical applications include:

Technical front ends

SMC/BMC is used for technical front-ends, whereby a single multi-functional SMC part can replace many individual metal parts. Inserts and fixings are moulded-in realising substantial savings in sub-assembly time that, in metal, would require separate welding and fixing operations. This structural application requires high dimensional accuracy.

Headlamp reflectors

BMC, in particular, is the material of choice in the headlamp reflector market. Good heat resistance is an essential requirement for head lamp shells, especially with the trend for narrower headlamps. Equally important is for the part to have good electrical insulating properties.

Engine under-covers and spare wheel wells

Cosmetics are not essential for these non-visible parts. Here, good strength and corrosion resistance against de-icing salts and engine bay acids and chemicals, are the main criteria.

Bumper beams

A full structural application where the part has to be capable of absorbing substantial impact stresses. SMC parts perform well in crash tests since the impact energy is dissipated through the fibre network.

Filter housings

SMC/BMC is used to produce components such as the filter housing that extract pollen, dust and other particles from the air before it reaches the passenger compartment. Parts integration is an important benefit in this application.



2.MASS TRANSIT

Train and light railways are another application area where the benefits of SMC/BMC can be fully exploited. As an excellent electrical insulator, SMC/BMC panels and components are used for spark guards and arc barriers. For interior fixtures and fittings like seat shells, arm rests, window frames, door panels and partition panels, the versatility of the material makes it a popular choice.

Special grades of SMC and BMC have been developed that not only give excellent flame retardancy but also meet all the relevant European and international FST (Flame, Smoke and Toxicity) standards. Smoke and the toxicity of combusted products are a major concern - especially in mass transportation due to confined, densely populated environments like train carriages, (over-ground and particularly underground), platforms and tunnels.

The high strength and low weight of SMC are also important factors. From a design perspective, SMC makes it possible to design and configure bright, friendly and spacious interior layouts that are, at the same time, tough and vandal resistant. SMC/BMC offers a unique blend of properties combined with high levels of design freedom and the flexibility to integrate functional elements. Compared to traditionally used low smoke thermosets like phenolic compounds, SMC/BMC has the added benefit that it can be pigmented to a wide range of colours and does not show any post shrinkage.

*Flame retardant,
low smoke, low
toxicity – essential
requirements for
today's mass transit
vehicles*

Benefits of SMC/BMC in mass transit applications

- Excellent electrical insulating properties
- Design freedom (complex geometries and integration not possible in metals)
- Flame retardant and low smoke systems compliant with the highest European standards
- Halogen-free formulations mean extremely low smoke and low toxicity
- SMC / steel / aluminium hybrids are fully compatible
- Weight savings with excellent strength/stiffness
- Permeability of electronic waves for antenna systems
- Excellent sound dampening properties better than aluminium
- Mass colouration possible
- Resistant to corrosion and abrasion



Applications

Typical SMC/BMC
mass transit applications :

- Seats for trains, buses, trams and light railways
- Interior fittings, fixtures and cladding
- In-tunnel seating and furniture
- Spark guards
- Third rail covers
- Cable trays for inside tunnels
- Arc barriers
- Electrical insulators



3. ELECTRICAL / ELECTRO-TECHNICAL

Electrical applications were one of the earliest industrial uses for SMC/BMC. The material offered lower weight and toughness compared to ceramic parts, and better pigmentability than phenolic moulding materials. SMC/BMC provides an ideal combination of chemical resistance, mechanical strength, electrical insulation and heat resistance.

The formulations can be homogeneously coloured so that components do not require painting and the excellent flow properties enable the production of very complex shapes. Dimensional accuracy is maintained over a wide range of temperatures, which, combined with high strength and good creep resistance, make SMC/BMC ideal for switchgear, machine bases, street light canopies, cabinets, housings and other demanding applications.

BMC is frequently used for smaller, more intricate high precision parts such as the fuse carrier (right). Whereas SMC is ideal for electrical cabinetry and lighting canopies requiring higher mechanical properties.



Benefits of SMC/ BMC in electrical applications

- Excellent electrical insulating properties
- Design freedom (complex geometries and integration not possible in other materials)
- Flame retardant and low smoke systems compliant with the highest European standards
- Halogen-free formulations give extremely low smoke and low toxicity
- Dimensional accuracy over a wide range of temperatures
- Weight savings with excellent strength/stiffness
- Self coloured and fully pigmentable to a wide range of colours
- Corrosion resistant
- Creep resistant
- Maintenance-free

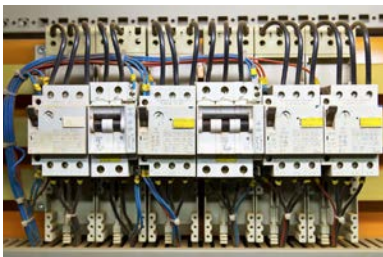

Lighting canopies

Benefits of SMC/BMC in lighting

- Maintenance-free
- Corrosion resistant – no need for anti- corrosion treatments
- Self coloured – no painting needed
- Weather and moisture resistant
- Excellent electrical insulating properties
- High mechanical strength – street light canopies resist strong wind loadings and mechanical fixings
- Creep resistant



Cabinets and meter boxes

Great experience has been gained in the production of cabinets, utility junction boxes and meter boxes. Life spans of over 40 years for SMC/BMC electrical cabinets are not unusual. For instance, the first SMC electrical meter cabinets were produced in 1963, and some of these are still in use. A major benefit is the materials resistance to weathering. Most SMC/BMC electrical cabinets are self coloured and have not been painted or surface treated in any way: yet UV radiation, rain, wind and temperature fluctuations have not produced any adverse effects. Metal cabinets corrode, but SMC modules only show a slight yellowing, matting or surface chalking over time.

Fire test comparison

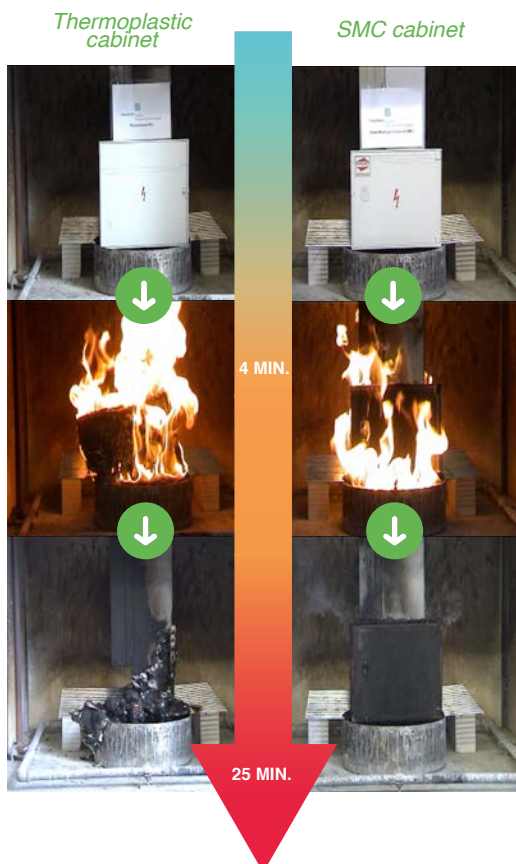

Flame retardancy is also a major advantage in this application versus other types of plastics as clearly shown below in this fire test between and SMC electrical meter cabinet and the same cabinet in thermoplastic. After fire testing for 25 minutes the thermoplastic cabinet on the left has been completely destroyed, while the SMC cabinet on the right has retained its structural integrity. The blackening effect does not show the cabinet carbonised but is rather the smoke layer from the oil burner used to ignite the cabinets.



Benefits of SMC/BMC for fire situation

- Resists ignition and burning
- Can be formulated to meet all standards for low heat, low smoke and low toxicity
- Retains structure even when consumed by fire
- Unlike thermoplastics, SMC/BMC does not melt or release burning droplets which spread fire
- State-of-the-art halogen-free formulations minimise toxic smoke emissions

4. DOMESTIC APPLIANCES

There are many applications for SMC/BMC all around us in our homes. For example both SMC and BMC are widely used to mould attractive kitchen sinks and worktops, as well as sanitary ware such as wash basins, shower trays and bath tubs. BMC is also found throughout the kitchen in household appliances where its high gloss cosmetic finish and good heat performance are ideal for irons, toasters, oven handles and coffee machines.

Domestic appliances favour BMC because competing materials have their limitations. Metals, for example, are temperature resistant but have no insulating properties, which restricts and often precludes their use. Thermoplastics are easily transformable, but their thermal behaviour is limited. Phenolic compounds can withstand high temperatures, but their colours are limited to black or brown.



Benefits of SMC/BMC in Domestic appliances

- **Injection moulding:** The process can be fully automated for high volume production and for post-moulding-operations. For small parts, cycle times well below 60 seconds are possible.
- **Thermal resistance:** The HDT (heat distortion temperature) of BMC is more than 200°C. The material will therefore not deform under the levels of heat generally encountered in electrical domestic appliances.
- **Resistance to chemical agents:** BMC parts are resistant to domestic cleaning agents, solvents, steam and water.
- **Mass colouring:** BMC parts can be mass pigmented to any colour to complement other components and accessories.
- **Food contact requirements:** Grades are available that comply with food hygiene requirements. Although not all parts are in direct contact with food, this is nevertheless a key criterion, for example in toasters.
- **Electrical insulation:** This is an intrinsic characteristic of the material. BMC is a natural insulator and easily meets safety requirements.
- **Fire Resistance:** Parts meet relevant UL and ISO fire safety standards, depending on the final application.
- **Glossy and smooth surface finish:** BMC recipes with low or zero shrinkage formulations give excellent surface qualities and aesthetic results.

As the parts are close to the heat source, heat resistance and Application examples



Irons

There are many types of irons on the market, in various designs and colours. Most have a BMC shield component that protects the water tank from the iron heating plate. The BMC part has to resist heat and water and must match the iron shell in terms of surface texture, gloss and colour.



Oven handles

Aesthetics are both important. Thanks to the good mouldability, BMC can produce attractive shapes and – unlike phenolics – BMC is fully pigmentable.

Thanks to recent advances in processability and new product formulations, BMC is making major inroads into the domestic appliance sector. Surface profile, dimensional accuracy, mechanical strength, heat resistance and electrical insulation are just some of the unique blend of properties that only BMC can deliver.



Waffle irons/sandwich makers

For grilling machines, waffle makers and sandwich toasters, the exterior shell and/or the handles are mostly made of BMC. The close proximity of the heating elements means that good heat resistance is essential, while the low thermal conductivity of the material minimises the heat transferred to the outer casing.

Towel dryer-heater

This part consists of a metal core and a BMC skin. The heating element is inserted in the press mould and the BMC is injected, having direct contact with the heating plate. It serves as a protective coating as well as improving the overall aesthetics.



BMC offers a unique blend of qualities for domestic appliances



5. BUILDING & CONSTRUCTION

A growth market for SMC/BMC is in building and construction. European markets for SMC/BMC include utility cabinets for telecommunication, gas or electrical housing, where the material is used for its corrosion resistance, good electrical insulating properties, high strength, excellent weathering resistance and freedom from maintenance. Lighting canopies and street furniture such as telephone boxes, benefit from these same qualities. SMC/BMC finds many other uses in building applications such as inspection chambers, modular balconies, water tank panels. Access covers, drainage grids and motorway signs are also made from SMC. In these instances the drivers are not just low weight and low maintenance but also the fact that, unlike metals, composites have no scrap value so they are not stolen.

Elsewhere in the world SMC is more of a mainstream material for domestic and commercial fixtures. For example in the US it is used for kitchen sinks and work surfaces - often with a powder in-mould coating for extra surface protection. It is also used for wall cladding, ceiling panels, doors, heavy duty window frames and even roof shingles. While in Japan, SMC is the material of choice for sanitary furniture, especially bathtubs.

SMC/BMC can often work out cheaper than traditional materials and other benefits include self colouring and the ability to replicate natural materials (e.g. wood effect doors). Flame retardant grades are available compliant with all European fire and safety standards, and the material is also resistant to corrosion and vandalism. Excellent sound dampening and electrical insulation properties are a further benefit. There is therefore excellent potential, for the European SMC/BMC industry to take a larger market share in the lucrative building and construction segment.

Benefits of SMC/ BMC in Building & Construction

- Flame retardant and low smoke systems compliant with all European standards
- Low weight compared to traditional materials like steel, iron and concrete making installation faster and cheaper
- Highly water resistant and ideal for potable water storage
- Excellent mechanical and physical properties
- Excellent electrical insulation and creep resistance
- Highly resistant to weathering, and humidity
- Design freedom (complex geometries and integration of parts and functions)
- Ideal for very complex parts
- High dimensional accuracy from very low to very high temperatures
- Excellent sound dampening qualities
- Mass pigmented
- Tough and durable
- Resistant to vandalism
- Resistant to corrosion and corrosive environments



SMC underground junction box. These modular boxes are used to replace brick chambers built in-situ, and are used for joining pipes, drains and cables. Good mechanical strength and resistance to acid and alkali attack are essential requirements.

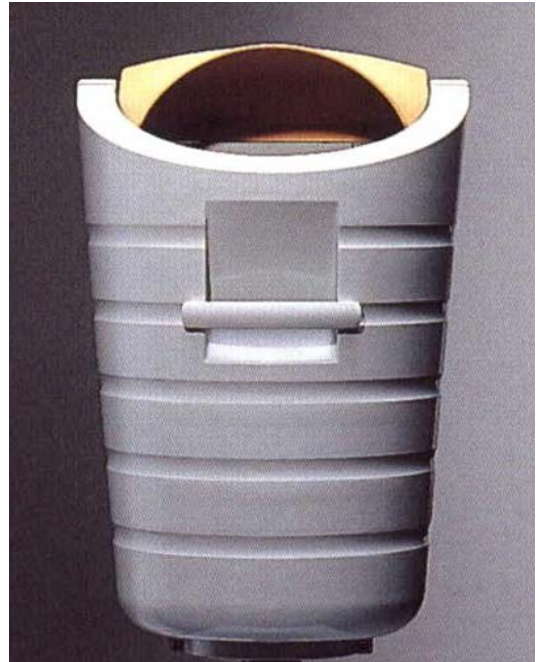

SMC waste bins. SMC solves the need for street furniture that looks good and is also strong, functional and flame retardant.



Satellite aerials are frequently made from SMC/BMC.



Fluid control valve. SMC/BMC has largely replaced metals in fluid control valves due to its corrosion resistance.



SMC sink units. Good resistance to staining, wear and thermal cycling are required for SMC sinks.



Archive storage box. These file boxes for archive storage had to comply with strict standards on flame retardancy.



Key cutting machine. Mechanical strength and design freedom were important criteria in this application.



SMC grids. As well as being lighter than cast iron equivalents, SMC grids, gratings and manhole covers also have no scrap value so there is no danger of theft. The same applies to motorway road signs where SMC is being used to replace aluminium for the same reason.

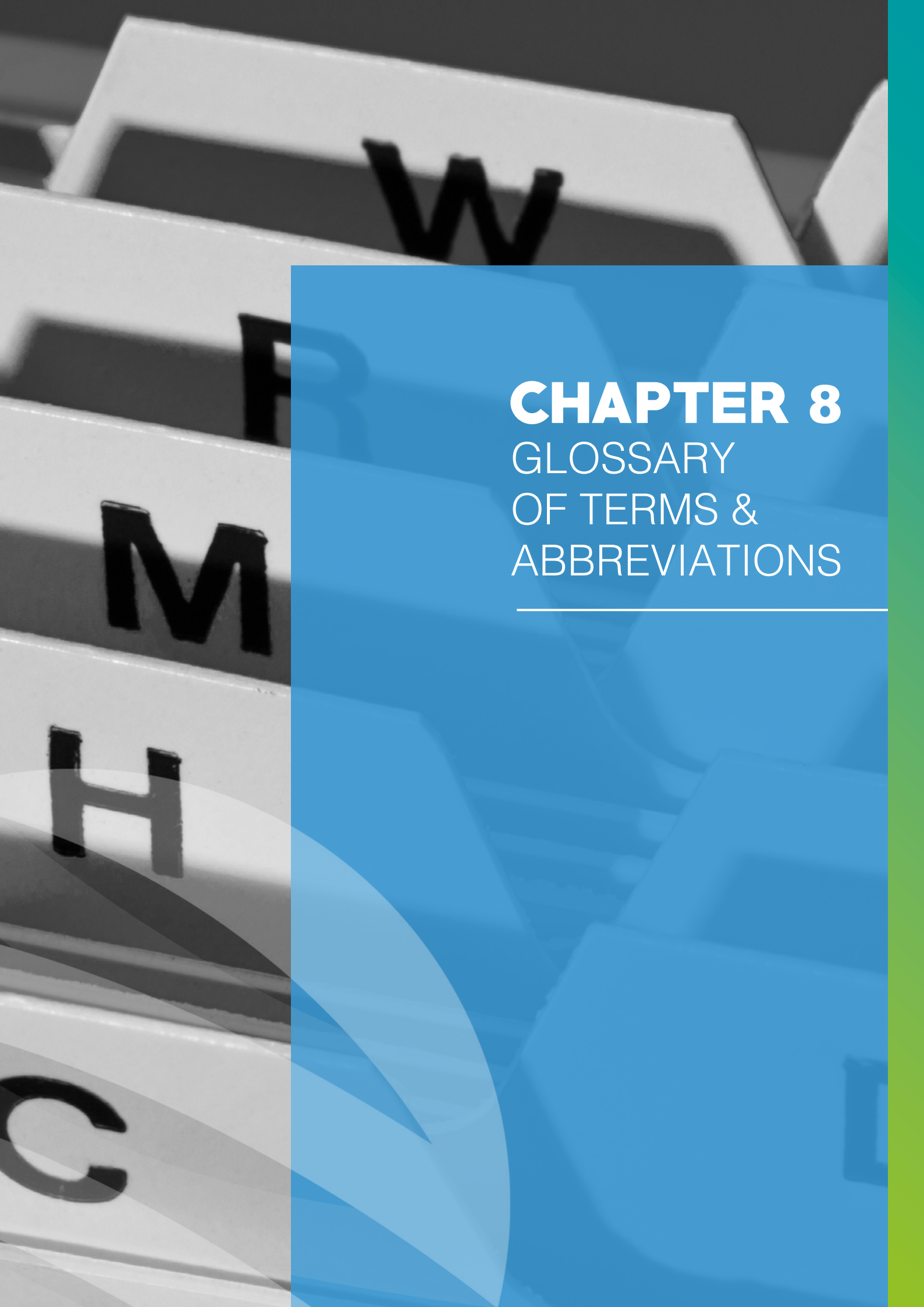

CHAPTER 8
GLOSSARY
OF TERMS &
ABBREVIATIONS

Glossary of terms & abbreviations

ATH: Aluminium Trihydrate $Al(OH)_3$ a filler used in fire retardant, low smoke emission SMC/BMC formulations.

Blister: Raised area on an SMC laminate surface caused by the presence of gases under pressure within the substrate.

BMC: Bulk Moulding Compound. A ready-to-mould fibre reinforced polyester material primarily used in injection moulding. Variants: CIC, TMC.

Body-in-White: A term used to describe the first major step in automotive production where the steel car body is assembled. The sheet metal parts are formed by stamping and joined mainly by hemming, spot welding or adhesive bonding. After the car body is completed it is then transferred into the so called paint shop to get painted.

Bond Line Read Through: A visible surface imperfection on a Class A surface caused by shrinkage of adhesive used to bond the inner panels.

Carrier Film: A nylon film used in the manufacture of SMC. The carrier film is removed prior to moulding.

Catalyst: A chemical additive that causes a cross-linking reaction that turns a liquid polyester resin into a solid.

Cavity: The female portion of a two-piece matched mould.

Charge Pattern: A pre-weighed number of SMC plies cut from the SMC roll, for placement in the mould.

Chrome Plating: Chrome plating of press moulds being used for the moulding of LP-SMC/BMC is highly recommended.

Class A Surface: Definition of the highest-quality surface finish technically achievable on exterior automotive body panels.

CLTE: Coefficient of linear thermal expansion. SMC: same as metals, making hybrid SMC/steel/aluminium structures feasible.

Composites: See FRP.

Contamination: Presence of foreign material in the moulded SMC laminates.

Crack, Fracture: Structural failure in the SMC part extending completely through the substrate.

Crack, Surface: Crack located on the surface of the SMC laminate that does not extend completely through the substrate.

Cracks, Ejector: Crack located on the SMC surface over or near an ejector pin.

Crazing: Hairline cracks in the part or on the part surface as a result of stress.

Creel: A storage rack that holds spools of glass roving for the manufacture of SMC.

Cross-linking: Chemical reaction of the reactive molecules that creates a network, which results in beneficial mechanical, dimensional and thermal end-properties.

Cure: See Cross-linking and Catalyst.

Cycle Time: The amount of time required to complete a full moulding cycle from mould preparation to part removal, 'from button to button'.

Dieseling: Burned spot on the SMC laminate, often accompanied by non fills. Dieseling is normally associated with air and styrene vapour entrapped in the tool, which ignites when under moulding temperatures and pressures.

Draft: The degree of taper allowed on the sides of a mould so the part can be removed.

Dull surface: Loss of gloss on the overall SMC part surface.

E-Coat: Electrophoresis coating used for corrosion protection for metals.

Edge Chips and Fibre Pulls: Small, irregularly shaped laminate tears located near the edge of the part.

Ejector Pins: A series of telescopic pins hidden in the (male) side of a mould that move in unison to lift a cured part from the mould.

Exotherm: The heat given off when resin cures by chemical reaction.

FEA: Finite Element Analysis. Computer analysis used to theoretically predict the structural integrity of a part using mathematical geometry and load simulation.

Fibre Orientation: The aligning of fibre reinforcements within the part that affect mechanical properties. The properties usually increase in the direction of alignment.

Glossary of terms & abbreviations

Flash: A thin membrane of scrap plastic formed on the edge of a moulded part. It is usually trimmed off as a secondary operation.

Flow Marks: Visual orientation of fibreglass strands on the moulded SMC part surface. Often, flow marks, phasing, and streaking appear similar and must be properly identified.

FRP: Fibre Reinforced Plastic. Generic term for all fibre reinforced plastics. Also called "Composites".

General Purpose: The standard class of SMC and BMC. See LP, LS.

Ghosting: The phenomenon where the outline of an inner panel can be seen on the surface of the outer panel.

HDT: Heat Deflection Temperature. The temperature at which a material specimen deflects a given distance under a given load using ASTM test procedures.

HLU: Hand Lay Up. A moulding technique in which the glass mat and resin are laid into an open cavity mould by hand. Used for small volume production, sampling or for making large components like boats etc.

In-Mould-Coating (IMC): A process in which a resin coating is introduced into the mould cavity after the SMC is cured. IMC prevents porosity in Class A parts and makes the painting process easier.

Knife Edge: A term used to describe a projection from the mould surface that has narrow included angle. Knife edges are considered undesirable for moulding SMC and BMC. (See Shear Edge).

Knit Lines, Flow Fronts: Extremely weak areas in the moulded SMC part resulting from convergence of flow fronts. Reinforcement orientation and minimal bridging of reinforcement across knit lines can significantly reduce laminate strength. Knit lines, to one degree or another, occur whenever two flow fronts meet, even when a single flow front is forced to flow around an obstruction such as a core pin.

Laking: Isolated dull areas on the surface of the moulded SMC part.

LP: Low Profile. A class of SMC or BMC with superior Class A surface characteristics. Usually not pigmentable.

LS: Low Shrink. A class of SMC and BMC with improved surface properties when compared to General Purpose. Usually pigmentable.

Maturation: A time period in the manufacture of SMC in which the viscosity of the resin matrix increases from liquid (sticky) to leather-like (almost no-tack), and is then ready for moulding.

Mould Release: A substance used to prevent a part sticking to the mould. Mould release (or release agent) is included into the SMC/BMC formulation.

Nonfill: Severe void in the SMC laminate resulting in an incomplete part.

OEM: Original Equipment Manufacturer, usually used in the automotive industry to denote the car or truck producer.

Orange Peel: A dimpled effect like the surface of an orange that can appear on painted parts.

Overflow: Machined pocket in the mould just outside the shear edge. During moulding, trapped air is allowed to vent to this area from the old cavity through a machined clearance in the shear edge. This results in a moulded part with less porosity and improved knit lines.

Polyester Resin: UP-Resin. The term generally used for unsaturated (means containing chemical double bonds) resins which are the basic components of SMC/BMC.

Porosity: Small voids (1 mm or less) that can appear individually or in clusters on the SMC surface.

Pregel: Localised area on the moulded SMC part that is dull and rough and normally contains porosity. This is caused by material starting to cure prior to completion of flow.

Press Parallelism: The ability of a hydraulic press to maintain the moulding surfaces in parallel to each other. Poor parallelism may cause uneven pressure distribution in the mould cavity and parts being thin at one edge, and thick at the opposite edge.

Resin-Rich Area: A section in the moulded SMC laminate where the reinforcement levels (glass content) is excessively low.

Rib Read-Out (Sink Marks): Surface depression caused by SMC shrinkage and located over ribs, bosses, or thick sections of the SMC part.

Glossary of terms & abbreviations

Shear Edge: A telescopic feature around the perimeter of the cavity of a compression mould where two mould halves are able to seal by bypassing each other. A shear edge allows air to escape from the cavity, but prevents SMC from passing through. Recommended for SMC/BMC. See Flash.

Shelf-Life Stability: The length of time a material will retain its moulding properties when stored in accordance with manufacturer's recommendations. Recommended storage temperatures: <20C.

Spring-back: Condition that occurs when a flat-rolled metal or alloy is cold-worked; upon release of the forming force, the material has a tendency to partially return to its original shape because of the elastic recovery of the material. This is called Spring-back and influenced not only by the tensile and yield strengths, but also by thickness, bend radius and bend angle.

SMC: Sheet Moulding Compound (also: Sheet Moulding Composite). A ready-to-mould fibre reinforced polyester material primarily used in compression moulding. The sheet is supplied in rolls up to 350 up to 1500kg.

SPC: Statistical Process Control: A method by which a production process can be monitored and control plans can be initiated to keep quality within acceptable limits.

Rib Read-Out (Sink Marks): Surface depression caused by SMC shrinkage and located over ribs, bosses, or thick sections of the SMC part.

Sticking: Physical adhesion of the moulded SMC part to the old, resulting in poor release and

potential cracking during part removal. Not to be confused with difficult part release due to LP-effect and inadequate draft angle. LP-SMC/BMC requires chrome plated press moulds.

Streaking (Abrasion): Dark areas, oriented in the line of flow and most commonly found in pigmented SMC parts.

Styrene: A liquid monomer used in polyester (UP) resin, that reacts during the cure to become part of the solid cross-linked thermoset matrix.

Surface Waviness (Ripples): Surface irregularity usually seen at the termination of flow on flat moulded SMC surfaces.

Thermoplastic (TP): A type of polymer material which can be repeatedly softened and reformed by heating, and rehardened by cooling.

Thermoset: A polymer material that undergoes a chemical cross-linking reaction before it becomes solid. Once it becomes solid, it cannot be reformed. Thermosets do not melt when heated.

UD-SMC: A form of SMC that has a uni-directional layer of reinforcement to increase strength and stiffness in the moulded part.

Undercure: Incomplete chemical cross-linking reaction while under moulding pressure, usually accompanied by a dull surface, styrene odour, catalyst odour, blisters, blown bosses, and/or delimitation of the SMC part.

Undercut: A negative or reverse draft in a mould that does not allow part removal without a special moveable section in the mould construction.

UP-GF-25, UP-GF-30: Terms used to indicate percentage by weight of glass fibres in the moulded SMC parts.

UP-Resin: See Polyester Resin. Unsaturated Polyester Resin keeps its name, even in the cured, saturated stage.

Vacuum Assist: Vacuum assisted moulding results in better SMC flow, easy mould fill, better air escape from the cavity and less porosity. It is recommended for Class A parts and visible parts.

Viscosity: A measure of resistance of a liquid to flow. Unit: mPas.

Warpage: SMC part distortion, shrinkage, or undue stress in the finished moulding (part does not duplicate the tool after moulding).

Wet-out: The ability of a resin or resin-filler-mix to impregnate a fibre reinforcement.

Whitening: General light or whitened appearance in the SMC moulded part's pigmented surface. Whitening is more evident in dark-coloured applications where polystyrene thermoplastic additive is not used.



CHAPTER 9

APPENDIX: MATERIAL
PROPERTIES OF SMC

Typical applications :

Auto OEM
Passenger &
commercial

Auto OEM
Passenger &
commercial

Auto OEM
Passenger &
commercial

Auto OEM
Passenger &
commercial

exterior panels

low density exterior
body panels

engine
components

bumper beams

Typical property	standard	units	Auto OEM Passenger & commercial	Auto OEM Passenger & commercial	Auto OEM Passenger & commercial	Auto OEM Passenger & commercial
Compounding process			SMC	SMC	SMC	SMC
Moulding process			Compression	Compression	Compression	Compression
Moulding temperature		°C	145 - 160	150-160	145-160	145-160
Moulding pressure 3)		bar	40 - 100	40-100	50-150	50-150
Moulding time		sec / mm	30	30	30	30
Available colours			natural	all	all	all
Density	ISO 1183 g/ccm	1.9	1.4	1.8	1.9	
Fibre content	EN ISO 1172	mass-%	30	30	30	50
Fibre type			Glass	Glass	Glass	Glass
Recycling code	VDA 260		UP - GF 30	UP - GF 30	UP - GF 30	UP-GF 50
Recyclability	-	-	Yes	Yes	Yes	Yes
Young´s modulus 1)	EN ISO 527-4	GPa	11.5	7	10.5	25/11
Tensile strength 1)	EN ISO 527-4	MPa	80	50	70	320/50
Tensile rupture strain 1)	EN ISO 527-4	%	1.5	1.3	1.4	1,5/0,9
Compression strength 1)	EN ISO 14126	MPa	150	120	165	450/160
Poisson´s ratio 1)	EN ISO 527-4	-	0.3	0.3	0.3	0,3/0,1
Flex modulus 1)	EN ISO 14125	GPa	10.5	7	10.5	24/11
Flexural strength 1)	EN ISO 14125	MPa	180	120	165	450/160
Impact strength 1)	EN ISO 179	KJ/m ²	90	50	70	280/50
Falling dart	ISO 6603	KJ/mm	8	8	8	
CTE 1)	ISO 11359-2	10-6m/mK	20	15	18	11/25
Continuous service temperature	Similar to IEC 216	°C	150	150	150	150
Short term service temperature	-	°C	210	210	210	210
Heat distortion temperature	EN ISO 75-2	°C	>200	>200	>200	>200
Specific heat capacity	-	J/gK	1.1	1.1	1.1	1.1
Shrinkage 2)	ISO 2577	%	-0.08	-0.02	0.1	-0,03/0,25
Post Moulding shrinkage	DIN 53464	%	0	0	0	
Volume resistivity	IEC 60093	Ohm*cm	10 ¹²	10 ¹²	10 ¹²	10 ¹²
Surface resistivity	IEC 60093	Ohm	10 ¹⁴	10 ¹⁴	10 ¹⁴	10 ¹⁴
Comparative tracking index I	EC 60112	CTI	600	600	600	600
Dielectric strength	IEC 60243-1	kV/mm	25	20	25	25
Dielectric constant	IEC 60250	-	4.9	4.6	4.5	4.5
Dissipation factor	IEC 60250	-	0.01	0.01	0.01	0.01
Oxygen index	EN ISO 4589-2	%	24	22	22	22
Flammability	UL 94	level/thickness	HB /1,6mm	HB /1,6mm	HB /1,6mm	HB /1,6mm
Flammability	ISO 3795	Class/thickness	NBR/3,2 mm	NBR/3,2	NBR/3,2mm	NBR/3,2 mm
Fire / smoke	EN 45545	Hazard Level				
Glow bar	IEC 60707	level	BH2-95	BH2-95	BH2-95	BH2-95
Glow wire	IEC 60965-2-1	°C	650	650	650	650
Water absorption	ISO 62	% after 24h	<0,3	<0,3	<0,3	<0,3
Chemical resistance	acidic cleaner automotive liquids Acids Salt solutions Alkalines solvents		o + - + o -	o + - + o -	o + - + o -	o + - + o -
Weather resistance			+	+	+	+
Paintability			+	+	o	o

Typical applications :

Typical property	standard	units	Auto OEM	Auto OEM	Auto OEM	Auto OEM
			Passenger & commercial	Passenger & commercial	Passenger & commercial	Passenger & commercial
			technical front-end	high density filter housing	under body panels	low density under body panels
Compounding process			SMC	SMC	SMC	SMC
Moulding process			Compression	Compression	Compression	Compression
Moulding temperature		°C	145 - 160	145-160	145-160	145-160
Moulding pressure 3)		bar	40 - 100	40-100	50-150	40-100
Moulding time		sec / mm	30	30	30	30
Available colours			all	all	all	all
Density	ISO 1183 g/ccm	g/ccm	1.9	2	1.8	1.4
Fibre content	EN ISO 1172	mass-%	30	30	25	25
Fibre type			Glass	Glass	Glass	Glass
Recycling code	VDA 260		UP - GF 30	UP - GF 30	UP - GF 25	UP-GF 25
Recyclability	-	-	Yes	Yes	Yes	Yes
Young´s modulus 1)	EN ISO 527-4	GPa	11.5	11,5	9	8
Tensile strength 1)	EN ISO 527-4	MPa	80	80	55	50
Tensile rupture strain 1)	EN ISO 527-4	%	1.5	1.5	1.5	1,5
Compression strength 1)	EN ISO 14126	MPa	150	150	160	140
Poisson´s ratio 1)	EN ISO 527-4	-	0.3	0.3	0.3	0,3
Flex modulus 1)	EN ISO 14125	GPa	10.5	10.5	9.5	8,5
Flexural strength 1)	EN ISO 14125	MPa	180	180	150	140
Impact strength 1)	EN ISO 179	KJ/m ²	90	90	60	50
Falling dart	ISO 6603	KJ/mm	8	8		
CTE 1)	ISO 11359-2	10-6m/mK	18	18	18	18
Continuous service temperature	Similar to IEC 216	°C	150	150	150	150
Short term service temperature	-	°C	210	210	210	210
Heat distortion temperature	EN ISO 75-2	°C	>210	>200	>200	>200
Specific heat capacity	-	J/gK	1.1	1.1	1.1	1.1
Shrinkage 2)	ISO 2577	%	0.1 ¹²	-0.1 ¹²	0.1 ¹²	0.1 ¹²
Post Moulding shrinkage	DIN 53464	%	0 ¹⁴	0 ¹⁴	0 ¹⁴	0 ¹⁴
Volume resistivity	IEC 60093	Ohm*cm	10	10	10	10
Surface resistivity	IEC 60093	Ohm	10	10	10	10
Comparative tracking index I	EC 60112	CTI	600	600	600	600
Dielectric strength	IEC 60243-1	kV/mm	25	25	25	20
Dielectric constant	IEC 60250	-	4.5	4.5	4.5	4.5
Dissipation factor	IEC 60250	-	0.01	0.01	0.01	0.01
Oxygen index	EN ISO 4589-2	%	22	22	22	22
Flammability	UL 94	level/thickness	HB /1,6mm	HB /1,6mm	HB /1,6mm	HB /1,6mm
Flammability	ISO 3795	Class/thickness	NBR/3,2 mm	NBR/3,2	NBR/3,2mm	NBR/3,2 mm
Fire / smoke	EN 45545	Hazard Level				
Glow bar	IEC 60707	level	BH2-95	BH2-95	BH2-95	BH2-95
Glow wire	IEC 60965-2-1	°C	650	650	650	650
Water absorption	ISO 62	% after 24h	<0,3	<0,3	<0,3	<0,3
Chemical resistance	acidic cleaner		o	o	o	o
	automotive liquids		+	+	+	+
	Acids		-	-	-	-
	Salt solutions		+	+	+	+
	Alkalines		o	o	o	o
	solvents		-	-	-	-
Weather resistance			+	+	+	+
Paintability			o	o	o	o

Typical applications :

Auto OEM
Passenger &
commercial

Auto OEM
Passenger &
commercial

Auto OEM
Passenger &
commercial

Auto OEM
Passenger &
commercial

technical
front-end

high density filter
housing

under body
panels

low density under
body panels

Typical property	standard	units	Auto OEM Passenger & commercial	Auto OEM Passenger & commercial	Auto OEM Passenger & commercial	Auto OEM Passenger & commercial
Compounding process			SMC	SMC	SMC	SMC
Moulding process			Compression	Compression	Compression	Compression
Moulding temperature		°C	150 - 170	145-160	145-160	155-160
Moulding pressure 3)		bar	100 - 200	40-100	50-150	100-160
Moulding time		sec / mm	15	30	30	30
Available colours			natur	all	all	black
Density	ISO 1183 g/ccm	g/ccm	2	1,8	1.9	1.6
Fibre content	EN ISO 1172	mass-%	12	25	50	54
Fibre type			Glass	Glass	Glass	Carbon
Recycling code	VDA 260		UP - GF 12	UP - GF 25	UP - GF 50	UP-GF 54
Recyclability	-	-	Yes	Yes	Yes	Yes
Young´s modulus 1)	EN ISO 527-4	GPa	13	9	13	32
Tensile strength 1)	EN ISO 527-4	MPa	25	55	160	200
Tensile rupture strain 1)	EN ISO 527-4	%	0.3	1.5	1.5	1,4
Compression strength 1)	EN ISO 14126	MPa	120	160	250	200
Poisson´s ratio 1)	EN ISO 527-4	-	0.3	0.3	0.3	0,3
Flex modulus 1)	EN ISO 14125	GPa	12	9.5	12	40
Flexural strength 1)	EN ISO 14125	MPa	80	150	280	400
Impact strength 1)	EN ISO 179	KJ/m²	15	60	150	70
Falling dart	ISO 6603	KJ/mm				
CTE 1)	ISO 11359-2	10-6m/mK	12	18	15	1,7
Continuous service temperature	Similar to IEC 216	°C	150	150	150	150
Short term service temperature	-	°C	220	210	210	210
Heat distortion temperature	EN ISO 75-2	°C	>200	>200	>200	>200
Specific heat capacity	-	J/gK	1.1	1.1	1.1	1.1
Shrinkage 2)	ISO 2577	%	-0.05	0.1	0.05	-0,12
Post Moulding shrinkage	DIN 53464	%		0	0	0
Volume resistivity	IEC 60093	Ohm*cm	10 ¹²	10 ¹²	10 ¹²	
Surface resistivity	IEC 60093	Ohm	10 ¹⁴	10 ¹⁴	10 ¹⁴	
Comparative tracking index I	EC 60112	CTI	600	600	600	
Dielectric strength	IEC 60243-1	kV/mm	25	25	25	
Dielectric constant	IEC 60250	-	4.6	4.5	4.5	
Dissipation factor	IEC 60250	-	0.01	0.01	0.01	
Oxygen index	EN ISO 4589-2	%	22	22	22	22
Flammability	UL 94	level/thickness	HB /1,6mm	HB /1,6mm	HB /1,6mm	HB /1,6mm
Flammability	ISO 3795	Class/thickness	NBR/3,2 mm	NBR/3,2	NBR/3,2mm	NBR/3,2 mm
Fire / smoke	EN 45545	Hazard Level				
Glow bar	IEC 60707	level	BH2-95	BH2-95	BH2-95	BH2-95
Glow wire	IEC 60965-2-1	°C	650	650	650	650
Water absorption	ISO 62	% after 24h	<0,3	<0,3	<0,3	<0,3
Chemical resistance	acidic cleaner		o	o	o	o
	automotive liquids		+	+	+	+
	Acids		-	-	-	-
	Salt solutions		+	+	+	+
	Alkalines		0	0	0	0
	solvents		-	-	-	-
Weather resistance			+	+	+	+
Paintability			+	0	0	0

Auto OEM
Passenger &
commercialAuto OEM
Passenger &
commercialAuto OEM
Passenger &
commercial

Typical applications :

structural parts

exterior panels

structural parts

Typical property	standard	units			
Compounding process			SMC	SMC	SMC
Moulding process			Compression	Compression	Compression
Moulding temperature		°C	155-160	155-160	155-160
Moulding pressure 3)		bar	100-160	100-160	100-160
Moulding time		sec / mm	30	30	30
Available colours			black	black	black
Density	ISO 1183 g/ccm	g/ccm	1,4	1.6	1.4
Fibre content	EN ISO 1172	mass-%	60	54	60
Fibre type			Carbon	Carbon	Carbon
Recycling code	VDA 260		UP - GF 60	UP - GF 54	UP-GF 60
Recyclability	-	-	Yes	Yes	Yes
Young's modulus 1)	EN ISO 527-4	GPa	37	32	37
Tensile strength 1)	EN ISO 527-4	MPa	300	200	300
Tensile rupture strain 1)	EN ISO 527-4	%	1.8	1,4	1,8
Compression strength 1)	EN ISO 14126	MPa	300	200	300
Poisson's ratio 1)	EN ISO 527-4	-	0.3	0,3	0,3
Flex modulus 1)	EN ISO 14125	GPa	47	40	47
Flexural strength 1)	EN ISO 14125	MPa	780	400	780
Impact strength 1)	EN ISO 179	KJ/m ²	85	70	85
Falling dart	ISO 6603	KJ/mm			
CTE 1)	ISO 11359-2	10-6m/mK	2,7	1,7	2,7
Continuous service temperature	Similar to IEC 216	°C	150	150	150
Short term service temperature	-	°C	210	210	210
Heat distortion temperature	EN ISO 75-2	°C	>200	>200	>200
Specific heat capacity	-	J/gK	1.1	1.1	1.1
Shrinkage 2)	ISO 2577	%	-0.1	-0.12	-0,1
Post Moulding shrinkage	DIN 53464	%	0	0	0
Volume resistivity	IEC 60093	Ohm*cm			
Surface resistivity	IEC 60093	Ohm			
Comparative tracking index I	EC 60112	CTI			
Dielectric strength	IEC 60243-1	kV/mm			
Dielectric constant	IEC 60250	-			
Dissipation factor	IEC 60250	-			
Oxygen index	EN ISO 4589-2	%	22	22	22
Flammability	UL 94	level/thickness	HB /1,6mm	HB /1,6mm	HB /1,6mm
Flammability	ISO 3795	Class/thickness	NBR/3,2	NBR/3,2mm	NBR/3,2 mm
Fire / smoke	EN 45545	Hazard Level			
Glow bar	IEC 60707	level	BH2-95	BH2-95	BH2-95
Glow wire	IEC 60965-2-1	°C	650	650	650
Water absorption	ISO 62	% after 24h	<0,3	<0,3	<0,3
Chemical resistance	acidic cleaner		0	0	0
	automotive liquids		+	+	+
	Acids		-	-	-
	Salt solutions		+	+	+
	Alkalines		0	0	0
	solvents		-	-	-
Weather resistance			+	+	+
Paintability			0	0	0

Typical applications :

E+E	E+E	E+E	E+E
-----	-----	-----	-----

electrical cabinets lamp housings ex proofed housings connector box

Typical property	standard	units				
Compounding process			SMC	SMC	SMC	SMC
Moulding process			Compression	Compression	Compression	Compression
Moulding temperature		°C	145 - 160	145-160	145-160	145-160
Moulding pressure 3)		bar	100 - 200	40-100	40-100	40-100
Moulding time		sec / mm	30	30	30	30
Available colours			all	all	black	all
Density	ISO 1183 g/ccm	g/ccm	1,8	1,8	1.9	1.8
Fibre content	EN ISO 1172	mass-%	25	20	30	25
Fibre type			Glass	Glass	Glass	Glass
Recycling code	VDA 260		UP - GF 25	UP - GF 20	UP - GF 30	UP-GF 25
Recyclability	-	-	Yes	Yes	Yes	Yes
Young´s modulus 1)	EN ISO 527-4	GPa	9	8	11,5	9
Tensile strength 1)	EN ISO 527-4	MPa	55	45	80	55
Tensile rupture strain 1)	EN ISO 527-4	%	1.5	1.5	1.5	1,5
Compression strength 1)	EN ISO 14126	MPa	160	140	150	160
Poisson´s ratio 1)	EN ISO 527-4	-	0.3	0.3	0.3	0,3
Flex modulus 1)	EN ISO 14125	GPa	9,5	8.5	10,5	9,5
Flexural strength 1)	EN ISO 14125	MPa	150	120	180	150
Impact strength 1)	EN ISO 179	KJ/m ²	60	40	90	60
Falling dart	ISO 6603	KJ/mm			8	
CTE 1)	ISO 11359-2	10-6m/mK	18	18	18	18
Continuous service temperature	Similar to IEC 216	°C	150	150	150	150
Short term service temperature	-	°C	210	210	210	210
Heat distortion temperature	EN ISO 75-2	°C	>200	>200	>200	>200
Specific heat capacity	-	J/gK	1.1	1.1	1.1	1.1
Shrinkage 2)	ISO 2577	%	0.1	0.1	0.1	0,1
Post Moulding shrinkage	DIN 53464	%	0	0	0	0
Volume resistivity	IEC 60093	Ohm*cm	10 ¹²	10 ¹²	10 ¹²	10 ¹²
Surface resistivity	IEC 60093	Ohm	10 ¹⁴	10 ¹⁴	10 ¹⁴	10 ¹⁴
Comparative tracking index I	EC 60112	CTI	600	600	600	600
Dielectric strength	IEC 60243-1	kV/mm	25	25	2,5	25
Dielectric constant	IEC 60250	-	4.5	4.5	NA	4.5
Dissipation factor	IEC 60250	-	0.01	0.01	NA	0.01
Oxygen index	EN ISO 4589-2	%	22	22	32	32
Flammability	UL 94	level/thickness	HB /1,6mm	HB /1,6mm	3HB /3,2mm	HB /3,2 mm
Flammability	ISO 3795	Class/thickness	NBR/3,2 mm	NBR/3,2	NBR/1,6mm	NBR/1,6 mm
Fire / smoke	EN 45545	Hazard Level				
Glow bar	IEC 60707	level	BH2-95	BH2-95	BH2-10	BH2-10
Glow wire	IEC 60965-2-1	°C	650	650	950	950
Water absorption	ISO 62	% after 24h	<0,3	<0,3	<0,3	<0,3
Chemical resistance	acidic cleaner automotive liquids Acids Salt solutions Alkalines solvents		o + - + o -	o + - + o -	+ + + + o -	+ + + + o -
Weather resistance			+	+	+	+
Paintability			o	o	o	o

E+E	E+E	E+E	E+E
-----	-----	-----	-----

Typical applications :

electrical cabinets lamp housings ex proofed housings connector box

Typical property	standard	units				
Compounding process			SMC	SMC	SMC	SMC
Moulding process			Compression	Compression	Compression	Compression
Moulding temperature		°C	145 - 160	145-160	145-160	145-160
Moulding pressure 3)		bar	100 - 200	40-100	40-100	40-100
Moulding time		sec / mm	30	30	30	30
Available colours			all	all	black	all
Density	ISO 1183 g/ccm	g/ccm	1,8	1,8	1.8	1.8
Fibre content	EN ISO 1172	mass-%	30	30	30	25
Fibre type			Glass	Glass	Glass	Glass
Recycling code	VDA 260		UP - GF 30	UP - GF 30	UP - GF 30	UP-GF 30
Recyclability	-	-	Yes	Yes	Yes	Yes
Young´s modulus 1)	EN ISO 527-4	GPa	10,5	10,5	10,5	10,5
Tensile strength 1)	EN ISO 527-4	MPa	70	70	70	70
Tensile rupture strain 1)	EN ISO 527-4	%	1.4	1.4	1.4	1,4
Compression strength 1)	EN ISO 14126	MPa	165	165	165	165
Poisson´s ratio 1)	EN ISO 527-4	-	0.3	0.3	0.3	0,3
Flex modulus 1)	EN ISO 14125	GPa	10,5	10.5	10,5	10,5
Flexural strength 1)	EN ISO 14125	MPa	165	165	165	165
Impact strength 1)	EN ISO 179	KJ/m ²	70	70	70	70
Falling dart	ISO 6603	KJ/mm	8	8	8	8
CTE 1)	ISO 11359-2	10-6m/mK	18	18	18	18
Continuous service temperature	Similar to IEC 216	°C	150	150	150	150
Short term service temperature	-	°C	210	210	210	210
Heat distortion temperature	EN ISO 75-2	°C	>200	>200	>200	>200
Specific heat capacity	-	J/gK	1.1	1.1	1.1	1.1
Shrinkage 2)	ISO 2577	%	0.1	0.1	0.1	0,1
Post Moulding shrinkage	DIN 53464	%	0	0	0	0
Volume resistivity	IEC 60093	Ohm*cm	10 ¹²	10 ¹²	10 ¹²	10 ¹²
Surface resistivity	IEC 60093	Ohm	10 ¹⁴	10 ¹⁴	10 ¹⁴	10 ¹⁴
Comparative tracking index I	EC 60112	CTI	600	600	600	600
Dielectric strength	IEC 60243-1	kV/mm	40	25	25	25
Dielectric constant	IEC 60250	-	4.5	4.5	4,5	4.5
Dissipation factor	IEC 60250	-	0.01	0.01	0,01	0.01
Oxygen index	EN ISO 4589-2	%	50	22	22	60
Flammability	UL 94	level/thickness	HB /1,6mm	HB /1,6mm	3HB /3,2mm	HB /3,2 mm
Flammability	ISO 3795	Class/thickness	NBR/3,2 mm	NBR/3,2	NBR/1,6mm	NBR/1,6 mm
Fire / smoke	EN 45545	Hazard Level				
Glow bar	IEC 60707	level	BH2-95	BH2-95	BH2-10	BH2-10
Glow wire	IEC 60965-2-1	°C	650	650	950	950
Water absorption	ISO 62	% after 24h	<0,3	<0,3	<0,3	<0,3
Chemical resistance	acidic cleaner		0	0	+	+
	automotive liquids		+	+	+	+
	Acids		-	-	+	+
	Salt solutions		+	+	+	+
	Alkalines		0	0	0	0
	solvents		-	-	-	-
Weather resistance			+	+	+	+
Paintability			0	0	0	0

Domestic appliances	Domestic appliances	Domestic Appliances
---------------------	---------------------	---------------------

Typical applications :

trays

letter box

Iron, Grill, Oven handle

Typical property	standard	units			
Compounding process			SMC	SMC	SMC
Moulding process			Compression moulding	Compression moulding	Injection moulding
Moulding temperature		°C	145-160	145-160	145-160
Moulding pressure 3)		bar	40-100	40-100	40-100
Moulding time		sec / mm	30	30	25
Available colours			all	all	all
Density	ISO 1183 g/ccm	g/ccm	1,8	1.8	1.9
Fibre content	EN ISO 1172	mass-%	25	30	20
Fibre type			Glass	Glass	Glass
Recycling code	VDA 260		UP - GF 25	UP - GF 30	UP-GF 20
Recyclability	-	-	Yes	Yes	Yes
Young´s modulus 1)	EN ISO 527-4	GPa	9	10,5	13
Tensile strength 1)	EN ISO 527-4	MPa	55	70	31
Tensile rupture strain 1)	EN ISO 527-4	%	1.5	1,4	0,4
Compression strength 1)	EN ISO 14126	MPa	160	165	160
Poisson´s ratio 1)	EN ISO 527-4	-	0.3	0,3	0,3
Flex modulus 1)	EN ISO 14125	GPa	9,5	10,5	9,5
Flexural strength 1)	EN ISO 14125	MPa	150	165	90
Impact strength 1)	EN ISO 179	KJ/m ²	60	70	25
Falling dart	ISO 6603	KJ/mm		8	
CTE 1)	ISO 11359-2	10-6m/mK	18	18	18
Continuous service temperature	Similar to IEC 216	°C	150	150	150
Short term service temperature	-	°C	210	210	210
Heat distortion temperature	EN ISO 75-2	°C	>200	>200	>200
Specific heat capacity	-	J/gK	1.1	1.1	1.1
Shrinkage 2)	ISO 2577	%	0.1	0.1	-0,1
Post Moulding shrinkage	DIN 53464	%	0	0	0
Volume resistivity	IEC 60093	Ohm*cm	10 ¹²	10 ¹²	10 ¹²
Surface resistivity	IEC 60093	Ohm	10 ¹⁴	10 ¹⁴	10 ¹⁴
Comparative tracking index I	EC 60112	CTI	600	600	600
Dielectric strength	IEC 60243-1	kV/mm	25	25	25
Dielectric constant	IEC 60250	-	4,5	4,5	4,5
Dissipation factor	IEC 60250	-	0,01	0,01	0,01
Oxygen index	EN ISO 4589-2	%	22	22	22
Flammability	UL 94	level/thickness	HB /1,6mm	HB /1,6mm	HB /1,6mm
Flammability	ISO 3795	Class/thickness	NBR/3,2	NBR/3,2mm	NBR/3,2 mm
Fire / smoke	EN 45545	Hazard Level			
Glow bar	IEC 60707	level	BH2-95	BH2-95	BH2-95
Glow wire	IEC 60965-2-1	°C	650	650	650
Water absorption	ISO 62	% after 24h	<0,3	<0,3	<0,3
Chemical resistance	acidic cleaner		+	+	+
	automotive liquids		+	+	+
	Acids		+	+	+
	Salt solutions		+	+	+
	Alkalines		0	0	0
	solvents		-	-	-
Weather resistance			+	+	+
Paintability			0	0	0

Typical applications :

Building	Building	Building	Building
door panel	waste bin	waste water treatment	sectional water tank panels

Typical property	standard	units				
Compounding process			SMC	SMC	SMC	SMC
Moulding process			Compression	Compression	Compression	Compression
Moulding temperature		°C	145 - 160	145-160	145-160	145-160
Moulding pressure 3)		bar	40 - 100	40-100	40-100	40-100
Moulding time		sec / mm	30	30	30	30
Available colours			all	all	all	all
Density	ISO 1183 g/ccm	g/ccm	1,8	1,8	1.8	1.8
Fibre content	EN ISO 1172	mass-%	30	25	30	30
Fibre type			Glass	Glass	Glass	Glass
Recycling code	VDA 260		UP - GF 30	UP - GF 25	UP - GF 30	UP-GF 25
Recyclability	-	-	Yes	Yes	Yes	Yes
Young's modulus 1)	EN ISO 527-4	GPa	10,5	9	10,5	10,5
Tensile strength 1)	EN ISO 527-4	MPa	70	55	70	70
Tensile rupture strain 1)	EN ISO 527-4	%	1.4	1.5	1.4	1,4
Compression strength 1)	EN ISO 14126	MPa	165	160	165	165
Poisson's ratio 1)	EN ISO 527-4	-	0.3	0.3	0.3	0,3
Flex modulus 1)	EN ISO 14125	GPa	10,5	9.5	10,5	10,5
Flexural strength 1)	EN ISO 14125	MPa	165	150	165	165
Impact strength 1)	EN ISO 179	KJ/m ²	70	60	70	70
Falling dart	ISO 6603	KJ/mm	8		8	8
CTE 1)	ISO 11359-2	10-6m/mK	18	18	18	18
Continuous service temperature	Similar to IEC 216	°C	150	150	150	150
Short term service temperature	-	°C	210	210	210	210
Heat distortion temperature	EN ISO 75-2	°C	>200	>200	>200	>200
Specific heat capacity	-	J/gK	1.1	1.1	1.1	1.1
Shrinkage 2)	ISO 2577	%	0.1	0.1	0.1	0,1
Post Moulding shrinkage	DIN 53464	%	0	0	0	0
Volume resistivity	IEC 60093	Ohm*cm	10 ¹²	10 ¹²	10 ¹²	10 ¹²
Surface resistivity	IEC 60093	Ohm	10 ¹⁴	10 ¹⁴	10 ¹⁴	10 ¹⁴
Comparative tracking index I	EC 60112	CTI	600	600	600	600
Dielectric strength	IEC 60243-1	kV/mm	25	25	25	25
Dielectric constant	IEC 60250	-	4.5	4.5	4,5	4.5
Dissipation factor	IEC 60250	-	0.01	0.01	0,01	0.01
Oxygen index	EN ISO 4589-2	%	22	22	22	22
Flammability	UL 94	level/thickness	HB /1,6mm	HB /1,6mm	HB /1,6mm	HB /1,6 mm
Flammability	ISO 3795	Class/thickness	NBR/3,2 mm	NBR/3,2	NBR/3,2mm	NBR/3,2 mm
Fire / smoke	EN 45545	Hazard Level				
Glow bar	IEC 60707	level	BH2-95	BH2-95	BH2-95	BH2-95
Glow wire	IEC 60965-2-1	°C	650	650	650	650
Water absorption	ISO 62	% after 24h	<0,3	<0,3	<0,3	<0,3
Chemical resistance	acidic cleaner automotive liquids Acids Salt solutions Alkalines solvents		+ + + + 0 -	+ + + + 0 -	+ + + + 0 -	+ + + + 0 -
Weather resistance			+	+	+	+
Paintability			0	0	0	0

Typical applications :

Building Warehousing

Building

Building & leisure

Building & protection

storage box, cadding

Bath tube, sink, shower pan

Jet ski, snow mobile

Helmets, telephone

Typical property	standard	units	Building Warehousing	Building	Building & leisure	Building & protection
Compounding process			SMC	SMC	SMC	SMC
Moulding process			Compression	Compression	Compression	Compression
Moulding temperature		°C	145 - 160	145-160	145-160	145-160
Moulding pressure 3)		bar	40 - 100	40-100	40-100	50-150
Moulding time		sec / mm	30	30	30	30
Available colours			all	all	all	all
Density	ISO 1183 g/ccm	g/ccm	1,8	1,8	1.8	1.9
Fibre content	EN ISO 1172	mass-%	25	25	30	50
Fibre type			Glass	Glass	Glass	Glass
Recycling code	VDA 260		UP - GF 25	UP - GF 25	UP - GF 25	UP-GF 50
Recyclability	-	-	Yes	Yes	Yes	Yes
Young´s modulus 1)	EN ISO 527-4	GPa	9	9	9	10,35
Tensile strength 1)	EN ISO 527-4	MPa	55	55	55	60
Tensile rupture strain 1)	EN ISO 527-4	%	1.5	1.5	1.5	1,6
Compression strength 1)	EN ISO 14126	MPa	160	160	160	260
Poisson´s ratio 1)	EN ISO 527-4	-	0.3	0.3	0.3	0,3
Flex modulus 1)	EN ISO 14125	GPa	9,5	9.5	9,5	11,25
Flexural strength 1)	EN ISO 14125	MPa	150	150	150	266
Impact strength 1)	EN ISO 179	KJ/m²	60	60	60	50
Falling dart	ISO 6603	KJ/mm				8
CTE 1)	ISO 11359-2	10-6m/mK	18	18	18	18
Continuous service temperature	Similar to IEC 216	°C	150	150	150	150
Short term service temperature	-	°C	210	210	210	210
Heat distortion temperature	EN ISO 75-2	°C	>200	>200	>200	>200
Specific heat capacity	-	J/gK	1.1	1.1	1.1	1.1
Shrinkage 2)	ISO 2577	%	0.1	0.1	0.1	0,1
Post Moulding shrinkage	DIN 53464	%	0	0	0	0
Volume resistivity	IEC 60093	Ohm*cm	10 ¹²	10 ¹²	10 ¹²	10 ¹²
Surface resistivity	IEC 60093	Ohm	10 ¹⁴	10 ¹⁴	10 ¹⁴	10 ¹⁴
Comparative tracking index I	EC 60112	CTI	600	600	600	600
Dielectric strength	IEC 60243-1	kV/mm	25	25	25	25
Dielectric constant	IEC 60250	-	4.5	4.5	4,5	4.5
Dissipation factor	IEC 60250	-	0.01	0.01	0,01	0.01
Oxygen index	EN ISO 4589-2	%	22	22	22	22
Flammability	UL 94	level/thickness	HB /1,6mm	HB /1,6mm	HB /1,6mm	HB /1,6 mm
Flammability	ISO 3795	Class/thickness	NBR/3,2 mm	NBR/3,2	NBR/3,2mm	NBR/3,2 mm
Fire / smoke	EN 45545	Hazard Level				
Glow bar	IEC 60707	level	BH2-95	BH2-95	BH2-95	BH2-95
Glow wire	IEC 60965-2-1	°C	650	650	650	650
Water absorption	ISO 62	% after 24h	<0,3	<0,3	<0,3	<0,3
Chemical resistance	acidic cleaner		+	+	0	0
	automotive liquids		+	+	+	+
	Acids		+	+	+	+
	Salt solutions		+	+	+	+
	Alkalines		0	0	0	0
	solvents		-	-	-	-
Weather resistance			+	+	+	+
Paintability			0	0	0	0

Typical property	standard	units	Passenger trains	Passenger trains	Passenger trains	Passenger trains
			rail exterior	arc quenching chamber	cover for power rail	Support for side conductor, third railbooth, mail box
Compounding process			SMC	SMC	SMC	SMC
Moulding process			Compression	Compression	Compression	Compression
Moulding temperature		°C	145 - 160	145-160	145-160	145-160
Moulding pressure 3)		bar	40 - 100	40-100	40-100	40-100
Moulding time		sec / mm	30	30	30	30
Available colours			all	all	all	all
Density	ISO 1183 g/ccm	g/ccm	1,8	1,8	1.8	1.9
Fibre content	EN ISO 1172	mass-%	30	30	30	50
Fibre type			Glass	Glass	Glass	Glass
Recycling code	VDA 260		UP - GF 30	UP - GF 30	UP - GF 30	UP-GF 50
Recyclability	-	-	Yes	Yes	Yes	Yes
Young´s modulus 1)	EN ISO 527-4	GPa	10,5	10,5	10,5	13
Tensile strength 1)	EN ISO 527-4	MPa	70	70	70	160
Tensile rupture strain 1)	EN ISO 527-4	%	1.4	1.4	1.4	1,5
Compression strength 1)	EN ISO 14126	MPa	165	165	165	250
Poisson´s ratio 1)	EN ISO 527-4	-	1.4	1.4	1.4	1,5
Flex modulus 1)	EN ISO 14125	GPa	9,5	9.5	9,5	11,25
Flexural strength 1)	EN ISO 14125	MPa	165	165	165	280
Impact strength 1)	EN ISO 179	KJ/m ²	70	70	70	150
Falling dart	ISO 6603	KJ/mm	8	8	8	
CTE 1)	ISO 11359-2	10-6m/mK	18	18	18	15
Continuous service temperature	Similar to IEC 216	°C	150	150	150	150
Short term service temperature	-	°C	210	210	210	210
Heat distortion temperature	EN ISO 75-2	°C	>200	>200	>200	>200
Specific heat capacity	-	J/gK	1.1	1.1	1.1	1.1
Shrinkage 2)	ISO 2577	%	0.1	0.1	0.1	0,1
Post Moulding shrinkage	DIN 53464	%	0	0	0	0
Volume resistivity	IEC 60093	Ohm*cm	10 ¹²	10 ¹²	10 ¹²	10 ¹²
Surface resistivity	IEC 60093	Ohm	10 ¹⁴	10 ¹⁵	10 ¹⁴	10 ¹⁵
Comparative tracking index I	EC 60112	CTI	600	600	600	600
Dielectric strength	IEC 60243-1	kV/mm	25	40	25	40
Dielectric constant	IEC 60250	-	4.5	4.5	4,5	4.5
Dissipation factor	IEC 60250	-	0.01	0.01	0,01	0.01
Oxygen index	EN ISO 4589-2	%	50	50	50	50
Flammability	UL 94	level/thickness	HB /1,6mm	HB /1,6mm	HB /1,6mm	HB /1,6 mm
Flammability	ISO 3795	Class/thickness	NBR/1,2 mm	NBR/1,2	NBR/1,2mm	NBR/1,2 mm
Fire / smoke	EN 45545	Hazard Level				
Glow bar	IEC 60707	level	BH2-95	BH2-95	BH2-95	BH2-95
Glow wire	IEC 60965-2-1	°C	650	650	650	650
Water absorption	ISO 62	% after 24h	<0,3	<0,3	<0,3	<0,3
Chemical resistance	acidic cleaner		+	+	+	+
	automotive liquids		+	+	+	+
	Acids		+	+	+	+
	Salt solutions		+	+	+	+
	Alkalines		0	0	0	0
	solvents		-	-	-	-
Weather resistance			+	+	+	+
Paintability			0	0	0	0

Typical applications :

Passenger trains

Passenger trains

Passenger trains

Passenger trains

rail exterior

arc quenching chamber

cover for power rail

Support for side conductor, third railbooth, mail box

Typical property	standard	units	Passenger trains	Passenger trains	Passenger trains	Passenger trains
Compounding process			SMC	SMC	SMC	SMC
Moulding process			Compression	Compression	Compression	Compression
Moulding temperature		°C	145 - 160	145-160	145-160	145-160
Moulding pressure 3)		bar	40 - 100	40-100	40-100	40-100
Moulding time		sec / mm	30	30	30	30
Available colours			all	all	all	all
Density	ISO 1183 g/ccm	g/ccm	1,8	1,8	1.8	1.9
Fibre content	EN ISO 1172	mass-%	30	30	30	50
Fibre type			Glass	Glass	Glass	Glass
Recycling code	VDA 260		UP - GF 30	UP - GF 30	UP - GF 30	UP-GF 50
Recyclability	-	-	Yes	Yes	Yes	Yes
Young´s modulus 1)	EN ISO 527-4	GPa	10,5	10,5	10,5	13
Tensile strength 1)	EN ISO 527-4	MPa	70	70	70	160
Tensile rupture strain 1)	EN ISO 527-4	%	1.4	1.4	1.4	1,5
Compression strength 1)	EN ISO 14126	MPa	165	165	165	250
Poisson´s ratio 1)	EN ISO 527-4	-	1.4	1.4	1.4	1,5
Flex modulus 1)	EN ISO 14125	GPa	9,5	9.5	9,5	11,25
Flexural strength 1)	EN ISO 14125	MPa	165	165	165	280
Impact strength 1)	EN ISO 179	KJ/m ²	70	70	70	150
Falling dart	ISO 6603	KJ/mm	8	8	8	
CTE 1)	ISO 11359-2	10-6m/mK	18	18	18	15
Continuous service temperature	Similar to IEC 216	°C	150	150	150	150
Short term service temperature	-	°C	210	210	210	210
Heat distortion temperature	EN ISO 75-2	°C	>200	>200	>200	>200
Specific heat capacity	-	J/gK	1.1	1.1	1.1	1.1
Shrinkage 2)	ISO 2577	%	0.1	0.1	0.1	0,1
Post Moulding shrinkage	DIN 53464	%	0	0	0	0
Volume resistivity	IEC 60093	Ohm*cm	10 ¹²	10 ¹²	10 ¹²	10 ¹²
Surface resistivity	IEC 60093	Ohm	10 ¹⁴	10 ¹⁵	10 ¹⁴	10 ¹⁵
Comparative tracking index I	EC 60112	CTI	600	600	600	600
Dielectric strength	IEC 60243-1	kV/mm	25	40	25	40
Dielectric constant	IEC 60250	-	4.5	4.5	4,5	4.5
Dissipation factor	IEC 60250	-	0.01	0.01	0,01	0.01
Oxygen index	EN ISO 4589-2	%	50	50	50	50
Flammability	UL 94	level/thickness	HB /1,6mm	HB /1,6mm	HB /1,6mm	HB /1,6 mm
Flammability	ISO 3795	Class/thickness	NBR/1,2 mm	NBR/1,2	NBR/1,2mm	NBR/1,2 mm
Fire / smoke	EN 45545	Hazard Level				
Glow bar	IEC 60707	level	BH2-95	BH2-95	BH2-95	BH2-95
Glow wire	IEC 60965-2-1	°C	650	650	650	650
Water absorption	ISO 62	% after 24h	<0,3	<0,3	<0,3	<0,3
Chemical resistance	acidic cleaner automotive liquids Acids Salt solutions Alkalines solvents		+ + + + 0 -	+ + + + 0 -	+ + + + 0 -	+ + + + 0 -
Weather resistance			+	+	+	+
Paintability			0	0	0	0

Notes:

All materials supplied by members of the European Alliance for SMC/BMC are in accordance with : (Altautoverordnung) 2000/53/EG, ROHS, WEE. SMC/BMC materials do not contain heavy metals, asbestos, halogens or other toxic materials.

All values given in this table are representative mean values taken from compression moulded flat panels by members of the European Alliance for SMC/BMC. Properties may vary due to modifications of products, moulding conditions or environmental influence. It is the user's obligation to verify specific data via his own tests and trials. Properties given are accurate to the best of our current know-how and experience.

Notice: No warranty or representation is given or implied as to the suitability of the product or information here given for any particular application. The determination of the suitability of the above information for any particular use is solely the responsibility of the user.

All reinforcement glass fibres used are Continuous Filament Glass Fibres (CFGF). Further information about the use can be found on

www.glassfibreeurope.eu

SMC and BMC are recyclable materials. For further information please contact

info@smcbmc-europe.org

- 1) Properties given as two values are vectorial properties longitudinal respectively transversal to the direction of main fibre orientation.
- 2) Negative values are expansion.
- 3) Moulding pressures are given for inside cavity measurements.
- 4) For any special inquiries regarding the parts and materials please contact any member company of the European Alliance for SMC/BMC

© European Alliance for SMC/BMC



Publisher

European Alliance for SMC/BMC

President: Henri MAGNAUD

80 Bd. A. Reyers

1030 Brussels - Belgium

E-mail : info@smcbmc-europe.org

Tel : +32 2 706 89 06

www.smcbmc-europe.org

Communication & Press Relations

Muriel GILBERT

E-mail : muriel@smcbmc-europe.org

Tel : +32 475 412 413

We trust that you will find this Design Manual interesting and informative. It is our intention to keep the manual up-to-date as new developments in technologies products, processes and applications come along. You can help by informing us of developments in your particular field or by suggesting any changes and updates to the current manual. Your input would be appreciated and welcomed.

Simply contact the European Alliance for SMC/BMC at the address above.

Acknowledgement

We thank all companies and associations who have helped by providing information, photographs, facts and figures to complete this manual.

This Design Manual is based on supplied information, facts, figures, illustrations and pictures published in good faith and believed to be accurate, correct and free from any publication or copyright restrictions. For permission to copy or otherwise reproduce any part of the Design Manual for commercial use requires prior permission from the European Alliance for SMC/BMC.

© European Alliance for SMC/BMC 2016



Members



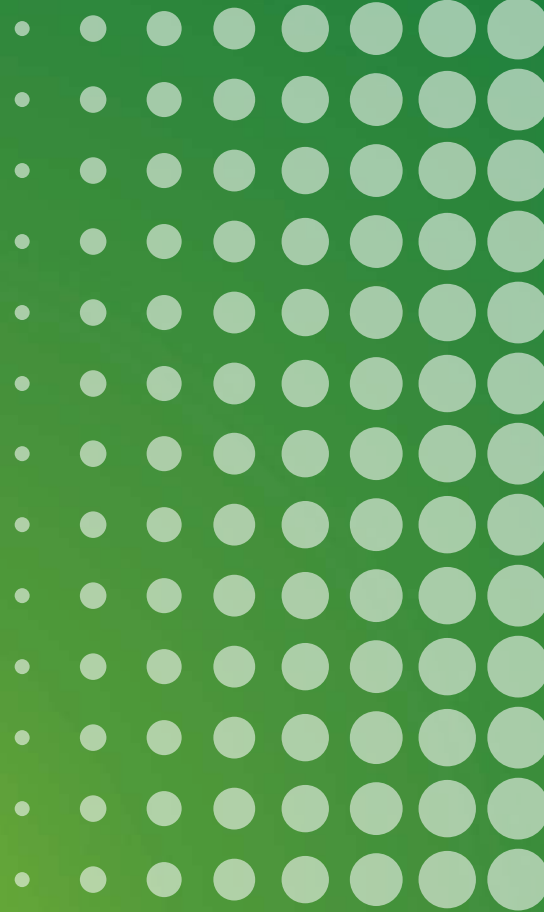

80 Bd. A. Reyers
1030 Brussels - Belgium

info@smcbmc-europe.org
+32 2 706 89 06

WWW.SMCBMC-EUROPE.ORG

Follow us on social networks  